



**TradeZone**

REV 01

# WHEEL & CASTOR PRODUCT GUIDE



Find a stockist near you at  
[www.tradezone.co.nz](http://www.tradezone.co.nz)

# Our Products

Wheels & castors, materials handling, trolleys & handtrucks, plastics & storage, gate hardware, conveyors, safety equipment, adjustable feet & inserts, bearings & sleeves, fasteners, hospitality equipment, and more.



Castors



Wheels



Trolleys & Handtrucks



Materials Handling



Skates & Dollies



Conveyors & Rollers



Plastics & Storage



Hospitality Equipment



Gate Hardware



Adjustable Feet  
& Inserts



WheelMakers for  
Industry

**For more information on the full range of products we stock, contact our staff or visit our website.**

# CONTENTS



## Furniture Castors

FURNITURE CASTORS	11
DESK & BED LEG CASTORS	13
FURNITURE DOLLIES	14
MINI SERIES CASTORS	15



## Light Duty Castors

UTILITY SERIES BOLT CASTORS	16
UTILITY SERIES PLATE CASTORS	17
UTILITY SERIES TWIN WHEEL	18



## Medium Duty Castors

COMMERCIAL SERIES CASTORS	19
LIGHT INDUSTRIAL SERIES CASTORS	20
ZINC DUROLITE SERIES CASTORS	21
CHROME DUROLITE SERIES CASTORS	23
200 SERIES CASTORS	25



## Heavy Duty Castors

300 SERIES BOLT HOLE CASTORS	26
300 SERIES PLATE CASTORS	27
SELF-ALIGNING CASTOR FRAME	28



## High Capacity Castors

HEAVY INDUSTRIAL SERIES CASTORS	29
HEAVY DUTY WELDED SERIES CASTORS	33
WASTE BIN CASTORS	34



## Pneumatic & Puncture Proof Castors

PNEUMATIC/PUNCTURE PROOF CASTORS	32
----------------------------------	----



## Over 500kg Capacity Castors

500 SERIES	35
1000 SERIES	37
FORGED HEAD SERIES	38
KINGPINLESS CASTORS	39



## Custom High Performance Castors

3000 SERIES CASTORS	40
HIGH PERFORMANCE SERIES	41
EXTRA HIGH PERFORMANCE SERIES	42
10 TONNE CASTORS	44



## Cargo & Transport

CONTAINER CASTOR MOUNTING PLATES	45
TOWMASTER SERIES	46
AVIATION PRODUCTS	47
SPRING LOADED CASTORS	48



## Stainless Steel & High/Low Temperature Castors

HIGH/LOW TEMPERATURE CASTORS	49
STAINLESS STEEL ELITE SERIES	51
STAINLESS STEEL EXCEL SERIES	53
STAINLESS HEAVY INDUSTRIAL SERIES	55



## Medical Castors

MEDI TWIN SERIES CASTORS	56
THERMOPLASTIC RUBBER MEDICAL CASTORS	57
CENTRAL LOCKING MEDICAL SERIES	58
ABS CENTRAL LOCKING MEDICAL CASTORS	59



## Refrigeration Castors

REFRIGERATION CASTORS	61
ADJUSTABLE STAINLESS CATERING LEGS	62



## Low Profile and Adjustable Height Castors

LOW PROFILE CASTORS	63
ADJUSTABLE HEIGHT CASTORS	64



## Scaffold & Platform Castors

SCAFFOLD CASTORS	65
------------------	----



## Gate Castors and Jockey Wheels

SPRING LOADED GATE CASTORS	67
JOCKEY WHEELS	68



## Glass Handling Ball Transfer Castors

GLASS BALL TRANSFER CASTORS	69
-----------------------------	----



## Baseplate Mounts

BASEPLATE MOUNTS	70
------------------	----



## Pneumatic & Puncture Proof Wheels

PNEUMATIC WHEELS	72
PUNCTURE PROOF WHEELS	74
OFFSET PNEUMATIC & PUNCTURE PROOF WHEELS	75



## Tyres & Tubes

INDUSTRIAL TYRES & TUBES	76
--------------------------	----



**Beach Wheels**

BALLOON BEACH WHEELS 77



**Lawn & Garden Wheels**

RUBBER TYRED NYLON CENTRED WHEELS 78  
SEMI-PNEUMATIC RUBBER TYRED WHEELS 79



**Rubber Tyred Wheels**

RUBBER TYRED NYLON WHEELS 80  
RUBBER TYRED CAST IRON CENTRED 80  
INSTITUTIONAL & ANTI-STATIC RUBBER 81  
REBOUND RUBBER WHEELS 82



**Polyurethane Wheels**

REBOUND POLYURETHANE TYRED WHEELS 83  
DONUT PROFILE ALUMINIUM CENTRE WHEELS 84  
CROWNED POLY ALUMINIUM CENTRE WHEELS 85  
POLYURETHANE TYRED NYLON CENTRED 87  
DRIVE WHEELS 88



**Drive Wheels**

DRIVE WHEELS 88



**High/Low Temp Wheels**

HIGH/LOW TEMPERATURE WHEELS 89



**Solid Nylon Wheels**

SOLID NYLON WHEELS 90



**Polyurethane & Nylon Rollers**

POLYURETHANE & NYLON ROLLERS 91



**Cast Iron & SG Wheels**

CAST IRON & SG WHEELS 92



**Cushion Rubber & Solid Pneumatic Wheels**

CUSHION RUBBER WHEELS 93  
SOLID PNEUMATIC WHEELS 93



**Concrete Agitator Rollers**

CONCRETE AGITATOR ROLLERS 94



**Track Wheels**

TRACK WHEELS - SINGLE FLANGE 95  
TRACK WHEELS - DOUBLE FLANGE 96  
TRACK WHEELS - BEAM TROLLEY 96  
TRACK WHEELS - V GROOVE 97  
TRACK WHEELS - ROPE GROOVE 97  
TRACK WHEELS - C GROOVE 98



**Ball Transfers**

BALL TRANSFER UNITS 99



**Flow & Skate Rails**

FLOW RAILS 100  
SKATE RAILS 100



**Conveyor Rollers**

CONVEYOR ROLLERS 102  
CUSTOM CONVEYOR SOLUTIONS 102



**Floor Locks**

FLOOR LOCKS 103



**Square & Round Tube Inserts**

SQUARE THREADED TUBE INSERTS 104  
ROUND THREADED TUBE INSERTS 104



**Adjustable Levelling Feet**

FIXED - RUBBER & STEEL BASE 105  
BOLT DOWN & FIXED - RUBBER BASE 106  
BALL JOINTED - RUBBER BASE 107  
FIXED - NYLON & NYLONE CON 108  
FIXED - STEEL/RUBBER & STEEL/NYLON 109



**End Caps**

RECTANGLE, SQUARE, AND ROUND END CAPS 110



**Sleeves & Top Hats**

SLEEVES & TOP HATS 111



**Fasteners**

SETS SCREWS & NUTS 113  
WASHERS, SET SCREWS, ANCHOR BOLTS 114



**Pintle Parts**

PINTLE PARTS 115



**Bearings & Axles**

BEARINGS 117  
AXLES 120



**Buffers**

BUFFERS 121



**Tricaster Dollies**

TRICASTOR STAGE DOLLIES 122

# Selecting The Right Wheel Or Castor For Your Application

## 5 Variables to consider when choosing your castor

### 1. LOAD CAPACITY

Heavier loads will require larger capacity castors with wheels made from higher density materials.

Sudden impacts that the wheel or castor may encounter during transport should also be considered. These sudden loads will add to the amount of force that is applied to the castor during transport.

To calculate the minimum load capacity, divide the typical weight by the number of castors to be used on the item. This number will give you the capacity for an evenly distributed load.



**CALCULATE THE THE CAPACITY YOUR CASTORS NEED TO BE**

**EQUIPMENT WEIGHT + LOAD WEIGHT**

---

**NO. CASTORS - 1**

E.G. Total weight of trolley and load = 400kg

If you divide this by 4 (one castor each corner), then each castor would need to be at least 100kg capacity (In this case the castors would running at their max limit)

If you divide by 3 instead, this will provide a safety margin for the application.

### 2. FLOOR TYPE

Wheels and castors perform differently depending on the floor surface.

- CARPET:**  
Nylon wheels are the best option due to the decreased rolling resistance.
- CONCRETE OR TILES:**  
Polyurethane, rebound rubber or other compound rubber wheels are the best option.
- UNEVEN SURFACE:**  
May lead to irregular weight distribution and temporarily increase the load on the castors.
- WOOD, VINYL, CORK & EPOXY FLOORS:**  
Non-marking wheels such as grey rubber, rebound rubber and polyurethane are best suited for these surfaces.
- EASILY MARKED SURFACES:**  
To prevent marking of the floor, polyurethane, rebound polyurethane, grey rubber, donut profile, or rebound rubber wheels are the best options.

Richmond has a wheel type to suit all floor surfaces

### 4. CLIMATE & ENVIRONMENT



Several requirements should be considered when choosing the right wheel or castor for your environment:

- Temperature to which the castor will be exposed, extreme heat or cold (Cool rooms, freezers, ovens)
- Will the wheel or castor be used in wet/wash down areas?
- Harshness of the environment (Sea water, dirt, sand, chemicals, clean room etc.)

Richmond's high/low temperature wheels can perform in extreme temperatures from **-30°C to 300°C**

### 3. EASE OF ROLLING

The major factors that contribute to rolling resistance are:

- Load
- Wheel Diameter
- Wheel Hardness
- Floor Surface  
The worse the floor, the bigger and softer the wheel needs to be

**Rolling resistance can be improved by selecting the largest suitable wheel diameter for your application.**

**When unsure, speak with the knowledgeable store staff to advise you on the most suitable castor for your application.**

### 5. APPLICATION

Are there any specific requirements or industry standards that your wheel/castor needs to meet? Below are some important things to consider when making a selection:



- Do the castors require brakes and/or directional locks?
- Is the load being towed, and if so at what speed?
- Wheel noise dampening
- Shock loads  
Will the load be subject to sudden shocks whilst moving?
- Frequency of use
- Height/clearance restrictions
- Mounting requirements  
Plate or bolt mount? Rigid, swivel, or brake frame?

# Wheels And Castors For All Applications



CATEGORY	LIGHT DUTY / GENERAL USE	MEDIUM DUTY	HEAVY DUTY / HIGH CAPACITY
LOADS	<b>40 - 100kg</b>	<b>100 - 250kg</b>	<b>250kg +</b>
DIAMETER	50 - 100mm	50 - 150mm	100 - 450mm
FRAMES	Single bolt mount in swivel, plate mount in swivel, rigid & brake varieties.	Mild or stainless steel. Single bolt mount in swivel, plate mount in swivel, rigid & brake varieties.	Mild or stainless steel. Plate mount in swivel, rigid, brake, and swivel lock & brake varieties.
WHEEL TYPE	Single & twin wheel castors.	Rebound rubber, nylon, polyurethane, high temp polymer and more.	Rebound rubber, nylon, polyurethane, high temp polymer, cast iron & SG iron and more.
APPLICATIONS	Household furniture, light duty cabinets, shop fitting, display equipment.	Medical & lab equipment, kitchens, cool rooms, bakeries, general industry and more.	Logistics, manufacturing, rapid moving production lines, steel manufacture, exhibition services, waste bins and more.

UP TO 100KG



### INSTITUTIONAL RUBBER

Designed for hospitals, nursing homes, offices, schools and any other light duty indoor applications these institutional rubber wheels feature non-marking tyres, sealed bearings and a matching grey thread guard.

UP TO 350KG

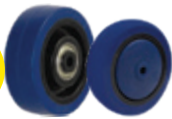

### REBOUND RUBBER

Non-marking, quiet and shock absorbing with a low rolling resistance compared to institutional rubber that ensures they move over small obstructions easily.

UP TO 600KG



### HIGH/LOW TEMPERATURE

Our wheels handle temperatures ranging from -30°C to 300°C. Cast iron, SG iron, glass filled nylon, aluminium, and high temperature polymer wheels are available.

UP TO 200KG



### PUNCTURE PROOF WHEELS

Eliminates the need to repair punctures. Suited to hand trucks, nursery and industrial equipment, these wheels combine the strength and stability of solid rubber wheel with the cushioned ride of a pneumatic.

UP TO 400KG



### POLY TYRED NYLON CENTRED

Features an injection moulded polyurethane tyre around a nylon hub, these wheels are hard wearing, non-marking and long lasting with high load capacities.

UP TO 5,000 KG



### POLY TYRED CAST IRON CENTRED

Available with a polyurethane hardness ranging from 60A to 75D on the shore scale, with a cast iron centre. FRAS (Fire Resistant Anti Static wheels are available to order)

UP TO 300KG



### PNEUMATIC WHEELS

Available with plastic or steel centre. Our pneumatic wheels offer an easy rolling solution ideal for use on agricultural equipment, hand trolleys, wheelbarrows and lots more.

UP TO 500KG



### SOLID NYLON

Highly durable wheel that has a low rolling resistance. Ideal for hard, smooth surfaces and outdoor/wet environments.

UP TO 5,000 KG



### CAST IRON & SG IRON

Ensures a high capacity with low rolling resistance. They are hard wearing as well as abrasive and heat resistant.

More in-depth information on our huge wheel & castor range can be found on our website [richmondnz.co.nz](http://richmondnz.co.nz)

## WHAT IS THE DIFFERENCE BETWEEN A WHEEL AND A CASTOR?



A wheel is a round object, usually with a centre hole for a spindle or axle.



A castor is a wheel contained in a rotating mount or frame. Allowing the wheel to be mounted to equipment.

## HOW WILL THE CASTOR BE MOUNTED?



### Plate Fixing

Best supported fitting. Either bolt or weld the castor frame to the product.



### Bolt Fixing

Ideal for fixing into tube. Suited for trolleys, racking, and display equipment.

**Make sure you check the baseplate dimensions or bolt size of the castor frame to ensure they meet your requirements.**

## CASTORS

### Rigid Castor:

Non-swivelling castor

### Swivel Castor:

Swivel rotates without restriction

## BRAKE TYPES

### Wheel Brake:

Prevents the wheel from rotating.

### Directional Lock:

Locks the swivel in any direction.

### Swivel Lock & Brake:

Simultaneously brakes the wheel and locks the swivel in any direction.

## BEARING TYPES

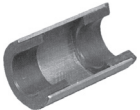

### PLAIN BORE WHEELS

are normally polypropylene, nylon or cast iron and are suitable for lighter loads where rolling resistance is not as important. They are used in very wet, corrosive or high heat conditions where better bearings would not survive.



### ROLLER BEARINGS

are suitable for medium duty applications. If kept well greased, they can cope with some dirt or water. Best service is given on hardened axles. These bearings do not require axial adjustment.



### PRECISION DEEP GROOVE BALL BEARINGS

are fitted to most of our heavy duty wheels. Such wheels have very low rolling resistance and are normally provided with double seal bearings that are 'sealed for life.' If the application required regular greasing, grease nipples can be fitted.



### TAPER ROLLER BEARINGS

are the best choice for power towing applications and have the highest carrying capacity. All wheels with taper roller bearings are fitted with oil seal sleeves. The axle design must allow for fine adjustment of distance between bearing cones.

## LOAD RATINGS

Our load capacities are based upon ideal/average working conditions. These ratings are for normal use. If the castors or wheels are in continuous use (e.g. as 24 hour a day drive wheels) these ratings would have to be downgraded. Ideal load ratings mean that the floor must be smooth and there is no chance of overloading the castor. Average load ratings are used when conditions are not perfect (i.e. probably on most sites where castors are used). It may be necessary to underate castors to ensure ease of use, especially under harsh conditions. Our castors are tested on a concrete floor free of door sills, breaks, rails etc and capacities are based on 'hand operation' except where otherwise designated.

## ROLLING RESISTANCE

The ease of moving a piece of equipment is determined by the resistance of the wheels to rolling (known as Rolling Resistance). Rolling resistance is described as “that effort required to move the equipment from rest and keep it moving.” The easiest rolling is achieved by hard tyred wheels on a hard smooth surface. However, if the wheels must overcome obstacles from rest, then the effort required includes the force needed to lift the wheels over the obstructions. Resilient tyred wheels (e.g. pneumatic tyred wheels) roll over these obstructions more easily, while both bearing wheels and larger wheels make it more and more easier.

**NOTE:** The graph to the right provides relative differences between wheel types assuming 150mm diameter wheels with precision ball bearings. Detailed advice can be given on request as many other factors need to be taken into account.

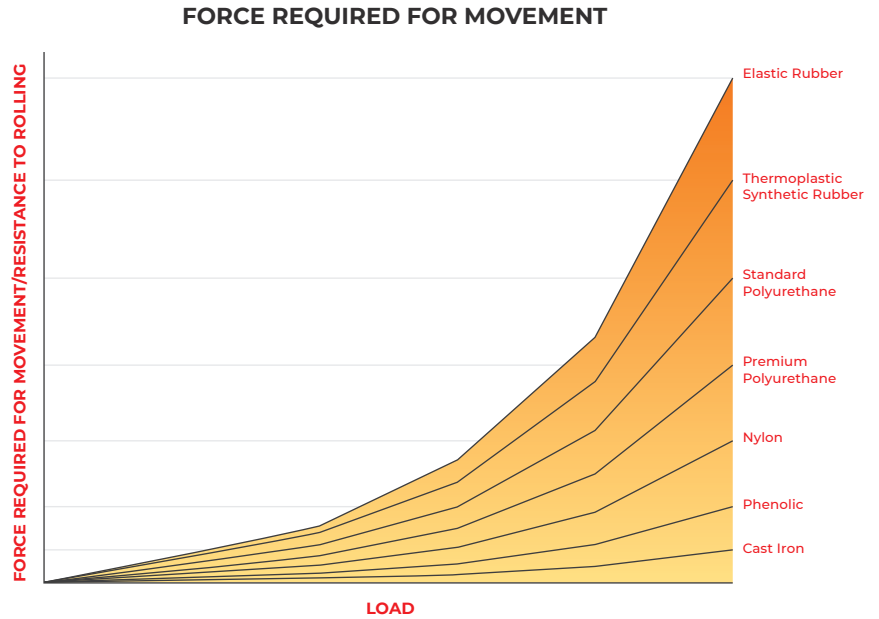

With so many variations to consider, the only realistic measurement of rolling resistance is actual site testing. Wheels are usually much cheaper to replace than the floors they run on. Cast iron wheels can damage concrete, especially if rolled over the same area. Nylon wheels are a good compromise and are long lasting. Rubber tyred wheels offer good protection, but are unable to carry the higher loads required of modern equipment. Polyurethane tyred wheels will not damage or mark floors and can carry high loads. Both cast iron and nylon wheels can often be noisy in operation. In areas where low noise levels are important, rubber or polyurethane tyred wheels are the best choice.

## CASTOR MOUNTING OPTIONS

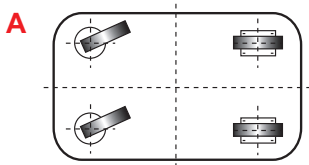

**SWIVEL CASTORS/  
RIGID CASTORS**

This solution offers excellent load bearing capacity and manoeuvrability and eliminates the danger of overturning uneven loads

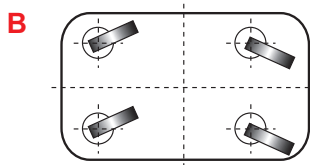

**SWIVEL CASTORS**

This solution is recommended for trolleys which will be required to work in confined spaces and will be pushed or pulled from all sides. It offers the advantage of excellent manoeuvrability and load capacity.

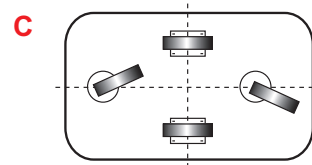

**SWIVEL CASTORS/  
RIGID CASTORS**

This solution combines an excellent load capacity with equally good manoeuvrability. The load is borne by the two central fixed wheels and the pivoting wheels. There is a danger of overturning if the load is off centre and the trolley is pulled from the side.

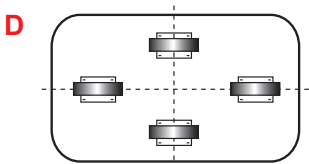

**RIGID CASTORS**

This solution is recommended for medium-sized loads and trolleys moved predominantly in a straight line. With no rotating parts on the castors, maintenance is kept to a minimum.

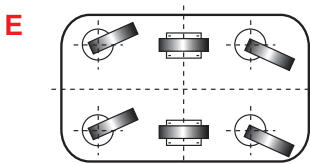

**SWIVEL CASTORS/  
RIGID CASTORS**

This is the best solution for large trolleys intended for heavy loads. It offers excellent load capacity and manoeuvrability with perfect stability. The trolley may be pushed or pulled from either of the ends with pivoting castors will pivot on half in length.



# CASTORS FOR ALL APPLICATIONS

Castors are what we do best. We have thousands of castor choices in our standard range, and if we don't have what you're looking for, we can design and manufacture it for you. Our castors are available with load capacities from 40kg up to 20T, with a large variety of wheel types and frame options.



# CUSTOM DESIGNED SOLUTIONS AVAILABLE

We're not just suppliers - we're creators. Our in-house engineering team can custom design and manufacture a solution to meet any requirement. Contact your local TradeZone trade outlet to find out how.

## LIGHT DUTY/ GENERAL USE

Light duty castors are designed to handle loads ranging between 40kg to 100kg per castor. These castors are suitable for every day applications including household furniture, light duty cabinets, shop fitting applications, display equipment and more.

## MEDIUM DUTY

Medium duty castors are designed to handle loads between 100kg and 250kg per castor. These castors are suitable for medical equipment, laboratory equipment, kitchens, cool rooms, general industry and more.

## HEAVY DUTY/ HIGH CAPACITY

Heavy duty castors are designed to handle loads between 250kg - 2T per castor. These castors are suitable for logistics, manufacturing, rapid moving production lines, steel manufacture, exhibition services, waste bin management and more.

# FURNITURE CASTORS

Richmond's range of furniture castors are made to suit most office furniture including chairs, trolleys and light duty cabinets such as TV units and display racking.

Featuring an economic and attractive twin wheel hooded design, these castors are perfect for DIY retro-fitting and returning rolling functionality to your furniture. This range is hard wearing and rolls over carpeted surfaces easily. A wide range of fitting options are available to suit all applications.



UP TO  
**40KG**  
CAPACITY

**SOLD IN  
PACKS  
OF 2**

Plate  
S50PK2

## TWIN WHEEL PLATE CASTOR

Diameter (mm)	Width (mm)	Wheel Type	Bearing Type	Height (mm)	Load Capacity (kg)	Swivel Radius (mm)	Swivel Code
50	43	Nylon	Plain	63	40	50	S50PK2

## TWIN WHEEL GRIP NECK CASTOR

Made to fit knock-in furniture sockets

Diameter (mm)	Width (mm)	Wheel Type	Bearing Type	Height (mm)	Load Capacity (kg)	Swivel Radius (mm)	Swivel Code
50	43	Nylon	Plain	63	40	50	S51PK2

## TWIN WHEEL THREADED STEM CASTOR

Made with a 3/8"(D) x 3/4"(L) BSW thread (suitable for most Australian beds)

Diameter (mm)	Width (mm)	Wheel Type	Bearing Type	Height (mm)	Load Capacity (kg)	Swivel Radius (mm)	Swivel Code
50	43	Nylon	Plain	63	40	50	S52PK2

## TWIN WHEEL FRICTION STEM CASTOR

11mm (D) x 25mm (L) friction stem to suit most office chairs

Diameter (mm)	Width (mm)	Wheel Type	Bearing Type	Height (mm)	Load Capacity (kg)	Swivel Radius (mm)	Swivel Code
50	43	Nylon	Plain	63	40	50	S53PK2

## Brake Options

B = Brake

To order castors with Brake add B to end of swivel code e.g. S51PK2B

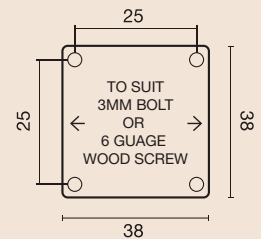

Baseplate dimensions for Furniture Series plate castors



Grip Neck S51PK2



Threaded Stem S52PK2



Friction Stem S53PK2

## MOUNTING FITTINGS FOR GRIP NECK FURNITURE CASTORS

Pintle	Pintle Code	Pintle Type	To Suit Castor
	PINTLER01	For 12.7mm ID Round Tube	S51PK2
	PINTLER03	For 19.0mm ID Round Tube	S51PK2
	PINTLER04	For 22.0mm ID Round Tube	S51PK2
	PINTLER07	For 16.0mm ID Round Tube	S51PK2
	PINTLER05	Grip Neck to suit Timber	S51PK2
	PINTLES01	For 16.0mm ID Square Tube	S51PK2
	PINTLES02	For 22.0mm ID Square Tube	S51PK2
	PINTLER02	For 19.0mm ID Round Tube C/W 3/8" BSW Thread	S51PK2
	PINTLER06	For 22.0mm ID Round Tube C/W 3/8" BSW Thread	S51PK2
	PINTLES03	For 22.0mm ID Square Tube C/W 3/8" BSW Thread	S51PK2
	PINTLES04	For 19.0mm ID Square Tube C/W 3/8" BSW Thread	S51PK2

# NON-MARKING FURNITURE CASTORS

Say goodbye to floor marks and scratches with Richmond's range of non-marking furniture castors.

These castors feature an attractive grey rubber wheel and are available in a variety of fitting options to suit all applications.

- Grey rubber wheels
- Variety of fitting options
- Will not scratch floors



UP TO  
**40KG**  
CAPACITY

SOLD IN  
PACKS  
OF 2

Plate  
S058PK2

## TWIN WHEEL PLATE CASTOR

Diameter (mm)	Width (mm)	Wheel Type	Bearing Type	Height (mm)	Load Capacity (kg)	Swivel Code
50	43	Non-marking rubber	Plain	63	40	S058PK2

## TWIN WHEEL GRIP NECK CASTOR

Made to fit knock-in furniture sockets

Diameter (mm)	Width (mm)	Wheel Type	Bearing Type	Height (mm)	Load Capacity (kg)	Swivel Code
50	43	Non-marking rubber	Plain	63	40	S055PK2

## TWIN WHEEL THREADED STEM CASTOR

Made with a 3/8"(D) x 3/4"(L) BSW thread (suitable for most Australian beds)





Diameter (mm)	Width (mm)	Wheel Type	Bearing Type	Height (mm)	Load Capacity	Swivel Code
50	43	Non-marking rubber	Plain	63	40	S054PK2

## TWIN WHEEL FRICTION STEM CASTOR

11mm (D) x 25mm (L) friction stem to suit most office chairs

Diameter (mm)	Width (mm)	Wheel Type	Bearing Type	Height (mm)	Load Capacity (kg)	Swivel Code
50	43	Non-marking rubber	Plain	63	40	S057PK2

## MOUNTING FITTINGS FOR GRIP NECK FURNITURE CASTORS

Pintle	Pintle Code	Pintle Type	To Suit Castor
	PINTLER01	For 12.7mm ID Round Tube	S055PK2
	PINTLER03	For 19.0mm ID Round Tube	S055PK2
	PINTLER04	For 22.0mm ID Round Tube	S055PK2
	PINTLER07	For 16.0mm ID Round Tube	S055PK2
	PINTLER05	Grip Neck to suit Timber	S055PK2
	PINTLES01	For 16.0mm ID Square Tube	S055PK2
	PINTLES02	For 22.0mm ID Square Tube	S055PK2
	PINTLER02	For 19.0mm ID Round Tube C/W 3/8" BSW Thread	S055PK2
	PINTLER06	For 22.0mm ID Round Tube C/W 3/8" BSW Thread	S055PK2
	PINTLES03	For 22.0mm ID Square Tube C/W 3/8" BSW Thread	S055PK2
	PINTLES04	For 19.0mm ID Square Tube C/W 3/8" BSW Thread	S055PK2

## Brake Options

B = Brake

To order castors with Brake add B to end of swivel code e.g. S055PK2B

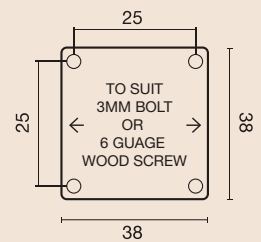

Baseplate dimensions for Furniture Series plate castors



Grip Neck S055PK2



Threaded Stem S054PK2



Friction Stem S057PK2

# DESK CASTORS

Richmond's range of desk castors feature a 'U' shape mounting bracket for fixing to 16mm-19mm thick MDF, chipboard and timber desks.

This castor is perfect for D.I.Y retro-fitting to existing desks and other furniture.

- 'U' shape mounting bracket
- Suitable for 16mm-19mm MDF, chipboard, timber
- Available with brake
- Up to 35kg load capacity per castor



S54BPK2



Diameter (mm)	Width (mm)	Wheel Type	Height (mm)	Load Capacity (kg)	Swivel Radius (mm)	U Bracket Size (mm)	Swivel Code
50	46	Nylon	61	35	68	16 x 35	S54PK2
50	46	Nylon	61	35	38	19 x 35	S57PK2

## Brake Options

B = Brake

To order castors with Brake add B to end of swivel code e.g. S54PK2B

# BED LEG CASTORS

Richmond's bed leg castor range is compatible with most major bed brands.

These castors and glides provide a convenient way to reposition or move your bedroom furniture on carpeted surfaces without damaging the pile.

They can also be used to provide additional clearance to allow for storage under a TV or display unit.

- Black nylon wheel or glide foot
- Suitable for carpeted surfaces
- 5/16" BSW or 3/8" BSW thread type



BEDLEG001PK2



BEDLEG005PK2



**Please Note:** as a rule of thumb if a standard HB hex pencil slides into the threaded hole in the bed, it is 3/8".

Part Type	Height (mm)	Thread Length (mm)	Thread Type	Load Capacity (kg)	Part Number
Castor	135	28	5/16" BSW	40	BEDLEG001
Castor with brake	135	28	5/16" BSW	40	BEDLEG002
Castor	135	28	3/8" BSW	40	BEDLEG003
Castor with brake	135	28	3/8" BSW	40	BEDLEG004
Glide	135	28	5/16" BSW	40	BEDLEG005
Glide	135	28	3/8" BSW	40	BEDLEG006

## Brake Options

B = Brake

To order castors with Brake add B to end of swivel code e.g. BEDLEG003PK2B

# WEIGHT ACTIVATED FURNITURE CASTORS

These castors feature a spring-loaded brake to keep your chair from rolling away when not in use.

When sitting down and placing weight on the castor, the brake will release allowing you to roll around in your chair as normal. When getting up from your chair, the castor will lock the wheel in place.

These castors are designed to suit most office chairs and feature a wire clip fitting.

- Grey polypropylene wheels
- Suitable for carpeted and tiled surfaces
- Wire clip fitting



S059PK2

UP TO  
**40KG**  
CAPACITY

SOLD IN  
PACKS  
OF 2

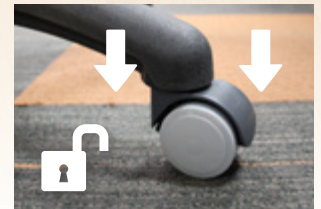

When weight is placed on the castor the brake will release.

Diameter (mm)	Width (mm)	Wheel Type	Bearing Type	Height (mm)	Load Capacity (kg)	Swivel Code
50	43	Polypropylene	Plain	63	40	S059PK2

# FURNITURE DOLLIE

These tri-wheel dollies are specifically designed for moving furniture, appliances and more.

They feature a concave center for moving items with legs, and a padded surface to protect items from damage.

- 3 x 1 1/2" swivel castors
- Concave center for items with legs
- Padded surface
- Up to 100kg load capacity per dolly



UP TO  
**100KG**  
CAPACITY

Wheel Diameter (mm)	Wheel Type	Bearing Type	Load Capacity	Height (mm)	Swivel Radius (mm)	Product Code
32	Polypropylene	Plain	100	50	135	TRICASTOR30

Heavy duty tricaster dollies available, see page 124 for details

# MINI SERIES CASTORS









Available in smaller wheel diameters ranging from 25-38mm, these castors are ideal for light duty furniture, plant trolleys, light duty carts, garage equipment and D.I.Y. projects.

- Smaller diameter castors
- White nylon wheels
- Not available with brake



S38NY



 Diameter (mm)	 Width (mm)	 Wheel Type	 Bearing Type	 Load Capacity (kg)	 Height (mm)	 Rigid Code	 Swivel Code
25	12	Nylon	Plain	10	36	R25NY	S25NY
32	14	Nylon	Plain	18	41	R32NY	S32NY
38	16	Nylon	Plain	28	50	R38NY	S38NY

Mini Series castors are not available with brake



S25NY



R32NY



R38NY



The tallest castor in this range is only 50mm high!

# UTILITY SERIES BOLT CASTORS

These bolt hole mounted castors are ideal for light duty applications including wire baskets, display equipment and light trolley applications.

They feature a corrosion resistant zinc plated finish in a pressed metal construction.

- Grey rubber or black nylon wheel
- Single bolt hole frame
- Pintle fittings available for round or square tubing



S4714B



Diameter (mm)	Width (mm)	Wheel Type	Wheel Code	Bearing Type	Load Capacity (kg)	Height (mm)	Swivel Radius (mm)	With Brake (mm)	Bolt Hole Size (mm)	Swivel Code
50	20	Inst Rubber	IR2201	Ball	30	68	49	75	10	S2714
50	20	Nylon	NY900	Plain	30	68	49	75	10	S2712
75	25	Inst Rubber	IR3301	Ball	50	98	65	85	10	S3714
75	25	Nylon	NY3324	Plain	50	98	65	85	10	S3712
100	25	Inst Rubber	IR4401	Ball	70	131	90	100	10	S4714
100	25	Nylon	NY4415	Plain	70	131	90	100	10	S4712

## Brake Options

B = Brake

To order castors with Brake add B to end of swivel code e.g. S4712B

## Castor Fitting Requirements

Fitting this castor to a 20mm thick base requires a 40mm x 10mm set screw.

These castors have a 10mm bolt hole but can be reduced to suit an 8mm bolt with a reduction bush (top hat).

10mm hole can be reduced to 8mm

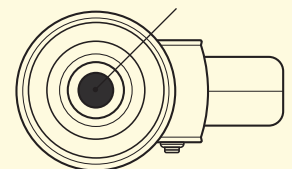

Reduction bush available to suit 8mm fittings, code: 100RED1008UT1

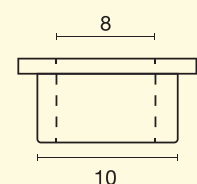

S2714









S3712



S4712B

## Nylon expanding pintles

Pintles listed below suit all Utility Series Bolt Castors

Pintle	Pintle Type	Pintle Code
	For 19mm ID Round Tube	UTI10-P1
	For 22mm ID Round Tube	UTI10-P2
	For 28.5mm ID Round Tube	UTI10-P3
	For 19mm ID Square Tube	UTI10-P4
	For 22mm ID Square Tube	UTI10-P5
	For 28.5mm ID Square Tube	UTI10-P6
	Single Bolt Fitting 10mm Various Bolt Lengths Available	



# UTILITY SERIES PLATE CASTORS



S3710B

These plate mounted castors are ideal for light duty applications including wire baskets, display equipment and light trolley applications.

They feature a corrosion resistant zinc plated finish in a pressed metal construction.

- Grey rubber or black nylon wheel
- Baseplate frame
- Available with brake

Diameter (mm)	Width (mm)	Wheel Type	Wheel Code	Bearing Type	Load Capacity (kg)	Height (mm)	Swivel Radius (mm)	With Brake (mm)	Rigid Code	Swivel Code
50	20	Inst Rubber	IR2201	Ball	30	69	50	77	R2711	S2710
50	20	Nylon	NY2900	Plain	30	69	50	77	R2709	S2708
75	25	Inst Rubber	IR3301	Ball	50	98	65	85	R3711	S3710
75	25	Nylon	NY3324	Plain	50	98	65	85	R3709	S3708
100	25	Inst Rubber	IR4401	Ball	70	134	90	100	R4711	S4710
100	25	Nylon	NY4415	Plain	70	134	90	100	R4717	S4716



R2711



S3708



S4710



S4716B

## Brake Options

B = Brake

To order castors with Brake add B to end of swivel code e.g. S3710B

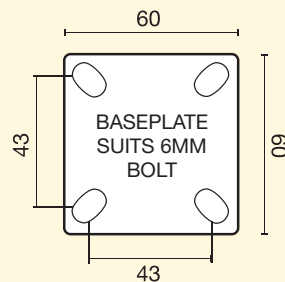

Baseplate for 50-75mm Swivel & Rigid Castors

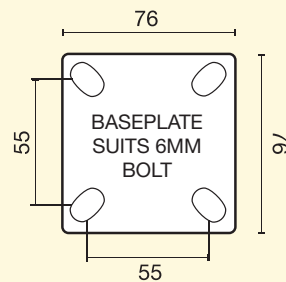

Baseplate for 100mm Swivel & Rigid Castors

# UTILITY SERIES TWIN WHEEL

## SINGLE BOLT OR BASEPLATE

These twin wheel castors are available in both bolt hole and plate mounted frames for a sturdier option.









- 2 x Grey rubber or 2 x black nylon wheels
- Baseplate frame or single bolt hole frame
- Available with brake



S3722



### TWIN WHEEL PLATE CASTORS











								
Diameter (mm)	Width (mm)	Wheel Type	Bearing Type	Load Capacity (kg)	Height (mm)	Swivel Radius (mm)	With Brake (mm)	Swivel Code
50	2 x 20	Rubber	Ball	50	71	60	80	S2718
50	2 x 17	Nylon	Plain	50	71	60	80	S2716
75	2 x 25	Rubber	Ball	80	101	70	100	S3718
75	2 x 25	Nylon	Plain	80	101	70	100	S3716

### Brake Options

B = Brake

To order castors with Brake add B to end of swivel code e.g. **S3722B**

### TWIN WHEEL BOLT CASTORS

									
Diameter (mm)	Width (mm)	Wheel Type	Bearing Type	Load Capacity (kg)	Height (mm)	Swivel Radius (mm)	With Brake (mm)	Bolt Hole Size (mm)	Swivel Code
50	2 x 20	Rubber	Ball	50	71	60	83	10	S2722
50	2 x 17	Nylon	Plain	50	71	60	83	10	S2720
75	2 x 25	Rubber	Ball	80	98	70	100	12	S3722
75	2 x 25	Nylon	Plain	80	98	70	100	12	S3720

### Castor Fitting Requirements

To fit this castor to a 20mm thick base requires a 40mm x 10mm set screw.

Reduction bush 100RED1008UT1 available to fit castors with an 8mm set screw.

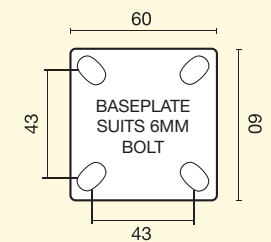

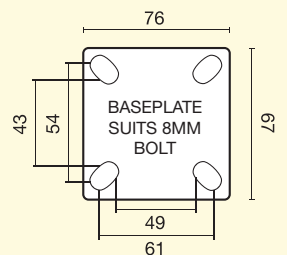

Baseplate for 50mm twin wheel – swivel



Baseplate for 75mm twin wheel – swivel

### Nylon expanding pintles

Pintles listed below suit all Utility Series Twin Wheel Bolt Castors

Pintle	Pintle Type	Pintle Code	Pintle Type	Pintle Code
	For 19mm ID Round Tube	<b>UTI10-P1</b>		S2722-WC
	For 22mm ID Round Tube	<b>UTI10-P2</b>		
	For 28.5mm ID Round Tube	<b>UTI10-P3</b>		
	For 19mm ID Square Tube	<b>UTI10-P4</b>	S2722-GN	
	For 22mm ID Square Tube	<b>UTI10-P5</b>		
	For 28.5mm ID Square Tube	<b>UTI10-P6</b>		

SEE page 115 FOR SOLID AND THREADED PINTLE OPTIONS

# COMMERCIAL SERIES CASTORS

An attractive black powder coated frame makes these castors an ideal choice for retail and display environments.

They are available with black polyurethane, grey rubber or black nylon wheels.

- Three wheel choices
- Black power coated frame
- Available with brake



**UP TO  
100KG  
CAPACITY**

**MOUNTING  
PLATES  
AVAILABLE  
page 70**

Diameter (mm)	Width (mm)	Wheel Type	Bearing Type	Load Capacity (kg)	Height (mm)	Swivel Radius (mm)	With Brake (mm)	Rigid Code	Swivel Code
50	20	Black Nylon	Plain	30	69	50	77	R2213	S2212
50	20	Grey Rubber	Ball Bearing	30	69	50	77	R2215	S2214
75	32	Polyurethane	Ball Bearing	80	108	71	108	R3399	S3398
100	32	Polyurethane	Ball Bearing	100	131	84	110	R4363	S4362



## Brake Options

B = Brake

To order castors with Swivel Lock Brake add B to end of swivel code e.g. S3398B

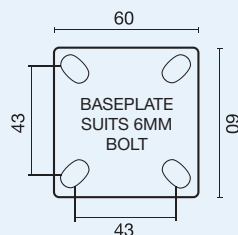

Baseplate for 50mm Swivel & Rigid Castors

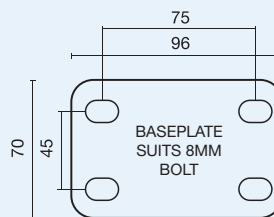

Baseplate for 75-100mm Swivel Castors

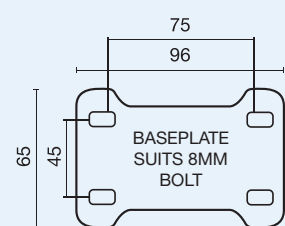

Baseplate for 75-100mm Rigid Castors

# LIGHT INDUSTRIAL SERIES CASTORS

This series is the ultimate choice for medium-duty applications. It offers a wide range of wheel types to suit different floor surfaces and load requirements.

The Light Industrial series is the preferred option for produce bins, market stalls and others as it provides an economical hard wearing reliable castor. It is also widely used on mobile equipment, in hospitals, nurseries, shops and general industry.

- Wide range of wheel types
- Suitable for medium-duty applications
- Available with brake



S4404B

Diameter (mm)	Width (mm)	Wheel Type	Wheel Code	Bearing Type	Load Capacity (kg)	Height (mm)	Swivel Radius (mm)	With Brake (mm)	Rigid Code	Swivel Code
75	32	Inst Rubber	IR3008	Ball	80	108	71	108	R3313	S3312
75	32	Reb Rubber	RR3348	Ball	80	108	71	108	R3351	S3350
75	32	Poly Nylon	PU3344	Ball	80	108	71	108	R3311	S3310
75	30	Nylon	NY3321	Plain	100	108	71	108	R3305	S3304
75	32	Cast Iron	Ci3340	Plain	100	108	71	-	R3307	S3306*
100	32	Hi-Temp Polymer	HT480	Oilless Du Bush	100	108	71	-	R4361	S4360*
100	32	Inst Rubber	IR4007	Ball	80	131	84	110	R4426	S4425
100	32	Reb Rubber	RR4473	Ball	100	131	84	110	R4405	S4404
100	32	Poly Nylon	PU4444	Ball	100	131	84	110	R4423	S4422
100	30	Nylon	NY4417	Plain	100	131	84	110	R4407	S4406
100	30	Hi-Temp Polymer	HT4420	Plain	100	131	84	-	R4403	S4402*
100	32	Hi-Temp Polymer	HT478	Ball	100	131	84	-	R4471	S4470*
100	36	Aluminium	AL472	Oilless Du Bush	100	131	84	-	R4381	S4380*
100	36	Aluminium	AL471	Bronze Bush	100	131	84	-	R4415	S4414*
125	32	Inst Rubber	IR5007	Ball	80	160	100	110	R5526	S5525
125	32	Reb Rubber	RR5573	Ball	100	160	100	110	R5505	S5504
125	32	Poly Nylon	PU5555	Ball	100	160	100	110	R5523	S5522
125	30	Nylon	NY5517	Plain	100	160	100	110	R5507	S5506

## Brake Options

B = Brake

To order castors with Brake add B to end of swivel code e.g. S3712B

indicates castors suitable for high/low temperature applications.

\* indicates castors not available with brake

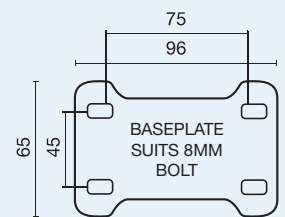

Baseplate for 75-125mm Rigid Castors

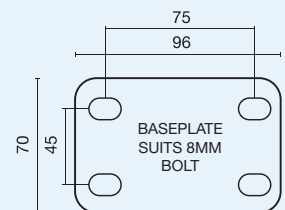

Baseplate for 75-125mm Swivel Castors



S3310B



S4406



S4380

# ZINC DUROLITE BOLT CASTORS



S5080B



This series is commonly used on a vast array of mobile equipment in hospitals, retail environments and general industry. A twin swivel race ensures longevity and enhances overall performance. These castors are available with a single bolt hole mount or a baseplate mount.

- Large variety of wheel types
- Baseplate frame or single bolt hole frame
- Available with brake

 Diameter (mm)	 Width (mm)	 Wheel Type	 Wheel Code	 Bearing Type	 Load Capacity (kg)	 Height (mm)	 Swivel Radius (mm)	 With Brake (mm)	 Bolt Hole Size (mm)	 Swivel Code
75	32	Inst Rubber	IR3008	Ball	80	107	71	105	12	S3080 #
75	32	Reb Rubber	RR3348	Ball	80	107	71	105	12	S3355 #
75	32	Poly Nylon	PU3344	Ball	80	107	71	105	12	S3330 #
75	30	Nylon	NY3321	Plain	80	107	71	105	12	S3326 #
100	32	Inst Rubber	IR4007	Ball	80	133	90	106	12	S4080
100	32	Anti Static	AS4005	Ball	100	133	90	106	12	S4493
100	32	Reb Rubber	RR4473	Ball	100	133	90	106	12	S4483
100	32	Poly Nylon	PU4444	Ball	100	133	90	106	12	S4484
100	30	Nylon	NY4417	Plain	100	133	90	106	12	S4485
125	32	Inst Rubber	IR5007	Ball	80	159	102	106	12	S5080
125	32	Anti Static	AS5005	Ball	100	159	102	106	12	S5593
125	32	Reb Rubber	RR5573	Ball	100	159	102	106	12	S5583
125	27	Poly Nylon	PU5555	Ball	100	159	102	106	12	S5584
125	30	Nylon	NY5517	Plain	100	159	102	106	12	S5585
150	32	Inst Rubber	IR6009	Ball	80	187	125	125	12	S6080
150	30	Poly Nylon	PU6660	Ball	100	187	125	125	12	S6081

## Brake Options

B = Brake  
D = Directional Lock

To order castors with Brake or Directional Lock add B or D to end of swivel code e.g. S6080B

# indicates castors not available with directional lock.

## Castor Fitting Requirements

To fit this castor to a 20mm thick base requires a 50mm x 12mm set screw. Reduction bush 100RED12100BT available to allow fitting with 10mm set screw.

These castors have a 12mm bolt hole but can be reduced to suit an 8mm or 10mm bolt with a reduction bush (top hat).

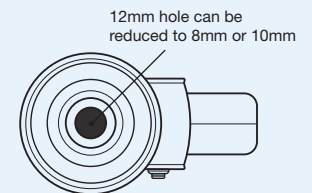



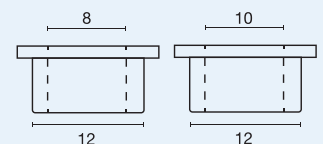



Reduction bushes available to suit 8mm fittings, code: 100RED12080BT  
to suit 10mm fittings, code: 100RED12100BT



## Nylon Expanding Pintles

Pintles listed below suit all Utility Series Bolt Castors

Pintle	Pintle Type	Pintle Code
	For 19mm ID Round Tube	OBT12-P1
	For 22mm ID Round Tube	OBT12-P2
	For 28.5mm ID Round Tube	OBT12-P3
	For 19mm ID Square Tube	OBT12-P4
	For 22mm ID Square Tube	OBT12-P5
	For 28.5mm ID Square Tube	OBT12-P6

SEE page 115 FOR SOLID AND THREADED PINTLE OPTIONS



S4483



S4485D

# ZINC DUROLITE PLATE CASTORS

MOUNTING  
PLATES  
AVAILABLE  
page 70

UP TO  
**100KG**  
CAPACITY

Diameter (mm)	Width (mm)	Wheel Type	Wheel Code	Bearing Type	Load Capacity (kg)	Height (mm)	Swivel Radius (mm)	With Brake (mm)	Rigid Code	Swivel Code
75	32	Inst Rubber	IR3008	Ball	80	107	71	105	R3105	S3104 #
75	32	Reb Rubber	RR3348	Ball	80	107	71	105	R3117	S3116 #
75	32	Poly Nylon	PU3344	Ball	80	107	71	105	R3107	S3106 #
75	30	Nylon	NY3321	Plain	100	107	71	105	R3103	S3102 #
100	32	Inst Rubber	IR4007	Ball	80	135	90	106	R4105	S4104
100	32	Anti Static	AS4005	Ball	80	135	90	106	R4121	S4120
100	32	Reb Rubber	RR4473	Ball	100	135	90	106	R4111	S4110
100	32	Poly Nylon	PU4444	Ball	100	135	90	106	R4107	S4106
100	30	Nylon	NY4417	Plain	100	135	90	106	R4103	S4102
100	30	GF/NYLON	NY4420	plain	100	135	90	106	R4123	S4122* ☀
100	32	Hi-Temp Polymer	HT480	Oilless Du bush	100	135	90	-	R4359	S4358* ☀
100	36	Aluminium	AL472	Oilless Du bush	100	133	90	-	R4113	S4112* ☀
125	32	Inst Rubber	IR5007	Ball	80	161	102	106	R5105	S5104
125	32	Anti Static	AS5005	Ball	80	161	102	106	R5121	S5120
125	32	Reb Rubber	RR5573	Ball	100	161	102	106	R5111	S5110
125	32	Poly Nylon	PU5555	Ball	100	161	102	106	R5107	S5106
125	30	Nylon	NY5517	Plain	100	161	102	106	R5103	S5102
150	32	Inst Rubber	IR6009	Ball	80	190	125	125	R6105	S6104
150	30	Poly Nylon	PU6660	Ball	100	190	125	125	R6107	S6106



S3104



S4110B



R5103



S6106

## Brake Options

B = Red Brake

D = Green Directional Lock

To order castors with Brake add B or D to end of swivel code e.g. S5110B

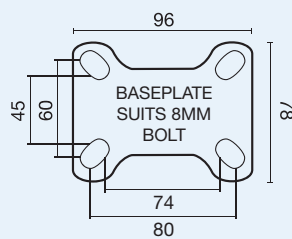

Baseplate for Rigid Castors

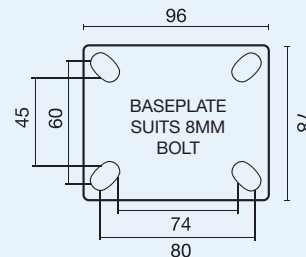

Baseplate for Swivel Castors

# indicates castors not available with directional lock.

\* indicates castors not available with brake



☀ indicates castors suitable for high/low temperature applications.

# CHROME DUROLITE BOLT CASTORS

These castors feature an attractive chrome finish, making them ideal for use in hospitals, institutions, nursing homes and retail displays.

A robust twin swivel race provides durability and longevity in the workplace.

- Large variety of wheel types
- Corrosion resistant chrome finish
- Baseplate frame or single bolt hole frame
- Available with brake



S5581

Diameter (mm)	Width (mm)	Wheel Type	Wheel Code	Bearing Type	Load Capacity (kg)	Height (mm)	Swivel Radius (mm)	With Brake (mm)	Bolt Hole Size (mm)	Swivel Code
75	30	Inst Rubber	IR3008	Ball	80	105	76	105	12	S3380 #
75	30	Poly Nylon	PU3344	Ball	80	105	76	105	12	S3381 #
100	32	Inst Rubber	IR4004	Ball	80	133	90	106	12	S4480
100	32	Anti Static	AS4005	Ball	80	135	90	106	12	S4469
100	27	Poly Nylon	PU4444	Ball	100	135	90	106	12	S4481
125	32	Inst Rubber	IR5004	Ball	80	159	102	106	12	S5580
125	32	Anti Static	AS5005	Ball	80	159	102	106	12	S5569
125	27	Poly Nylon	PU5554	Ball	100	159	102	106	12	S5581
150	32	Inst Rubber	IR6009	Ball	80	187	125	125	12	S6680
150	30	Poly Nylon	PU6660	Ball	100	187	125	125	12	S6681
150	30	Nylon	NY6617	Plain	100	187	125	125	12	S6682

## Brake Options

BR = Red Brake

D = Green Directional Lock

To order castors with Brake or Directional Lock add BR or D to end of swivel code e.g. S4480BR

# indicates castors not available with directional lock.

## Castor Fitting Requirements

To fit this castor to a 20mm thick base requires a 50mm x 12mm set screw. Reduction bush 100RED12100BT available to allow fitting with 10mm set screw.

## Nylon Expanding Pintles

Pintles listed below suit all Chrome Durolite Bolt Castors

Pintle	Pintle Type	Pintle Code
	For 19mm ID Round Tube	IPN12-P1
	For 22mm ID Round Tube	IPN12-P2
	For 28.5mm ID Round Tube	IPN12-P3
	For 19mm ID Square Tube	IPN12-P4
	For 22mm ID Square Tube	IPN12-P5
	For 28.5mm ID Square Tube	IPN12-P6
	Single Bolt Fitting Various Bolt Lengths Available	

SEE page 115 FOR SOLID AND THREADED PINTLE OPTIONS



S6682BR

These castors have a 12mm bolt hole but can be reduced to suit an 8mm or 10mm bolt with a reduction bush (top hat).

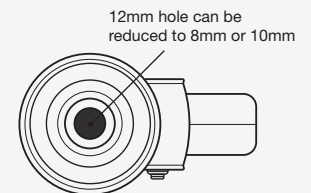

Reduction bushes available to suit 8mm fittings, code: 100RED12080BT  
to suit 10mm fittings, code: 100RED12100BT

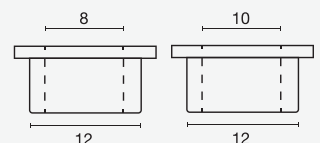

# CHROME DUROLITE PLATE CASTORS

UP TO  
**100KG**  
CAPACITY

MOUNTING  
PLATES  
AVAILABLE  
page 70



S4486BR



S5574



R5575

Diameter (mm)	Width (mm)	Wheel Type	Wheel Code	Bearing Type	Load Capacity (kg)	Height (mm)	Swivel Radius (mm)	With Brake (mm)	Rigid Code	Swivel Code
75	32	Inst Rubber	IR3008	Ball	80	107	70	105	<b>R3375</b>	<b>S3374 #</b>
75	32	Poly Nylon	PU3344	Ball	80	107	70	105	<b>R3373</b>	<b>S3372 #</b>
100	32	Inst Rubber	IR4004	Ball	80	135	90	106	<b>R4475</b>	<b>S4474</b>
100	32	Anti Static	AS4005	Ball	80	135	90	106	<b>R4509</b>	<b>S4508</b>
100	32	Poly Nylon	PU4444	Ball	100	135	90	106	<b>R4487</b>	<b>S4486</b>
125	32	Inst Rubber	IR5004	Ball	80	161	102	106	<b>R5575</b>	<b>S5574</b>
125	32	Anti Static	AS5005	Ball	80	161	102	106	<b>R5557</b>	<b>S5556</b>
125	32	Poly Nylon	PU5555	Ball	100	161	102	106	<b>R5587</b>	<b>S5586</b>
150	32	Inst Rubber	IR6009	Ball	80	190	125	125	<b>R6675</b>	<b>S6674</b>
150	30	Poly Nylon	PU6660	Ball	100	190	125	125	<b>R6689</b>	<b>S6688</b>
150	30	Nylon	NY6617	Ball	100	190	125	125	<b>R6685</b>	<b>S6684</b>

## Brake Options

BR = Red Brake  
D = Green Directional Lock

To order castors with Brake add BR or D to end of swivel code e.g. S5586D

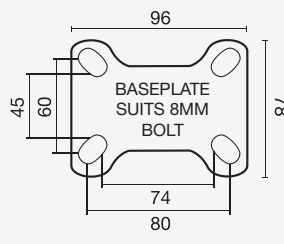

Baseplate for Rigid Castors

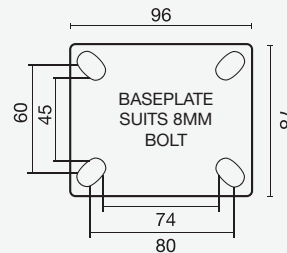

Baseplate for Swivel Castors

# indicates castors not available with directional lock.

# 200 SERIES CASTORS



S5600B

With a load capacity of up to 200kg, this series features a standout red nylon thread guard for extra protection against dirt and debris.

These castors are suitable for medium-duty applications and are available with a number of wheel types.

- Nylon, poly/nylon or rebound rubber wheels
- Available with brake

Diameter (mm)	Width (mm)	Wheel Type	Bearing Type	Load Capacity (kg)	Height (mm)	Swivel Radius (mm)	with Brake (mm)	Rigid Code	Swivel Code
80	38	Nylon	Ball Bearing	125	108	76	125	R3601	<b>S3600</b>
80	38	Poly/Nylon	Ball Bearing	100	108	76	125	R3603	<b>S3602</b>
80	38	Rebound Rubber	Ball Bearing	100	108	76	125	R3605	<b>S3604</b>
100	38	Nylon	Ball Bearing	200	128	90	125	R4601	<b>S4600</b>
100	38	Poly/Nylon	Ball Bearing	150	128	90	125	R4603	<b>S4602</b>
100	38	Rebound Rubber	Ball Bearing	150	128	90	125	R4605	<b>S4604</b>
125	38	Nylon	Ball Bearing	200	153	102	125	R5601	<b>S5600</b>
125	38	Poly/Nylon	Ball Bearing	150	153	102	125	R5603	<b>S5602</b>
125	38	Rebound Rubber	Ball Bearing	150	153	102	125	R5605	<b>S5604</b>



S3310B



S4406



S4380

## Brake Options

B = Brake

To order castors with Brake add B to end of swivel code e.g. S3604B

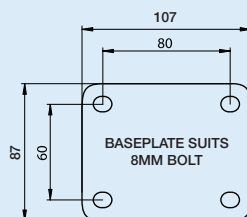

Baseplate for Swivel Castors

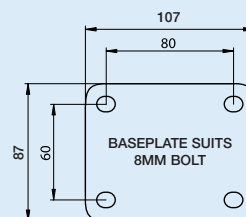

Baseplate for Rigid Castors

# 300 SERIES BOLT CASTORS

This castor series has a higher load capacity of up to 300kg, making it perfect for a wide range of uses.















In this range, nylon wheels are the most common choice for industrial and trolley applications, rebound rubber wheels are ideal for road cases and transportable crates, while poly nylon wheels are best suited for undercover and showroom displays.

- Large variety of wheel types
- Baseplate frame or single bolt hole frame



S5218B



 Diameter (mm)	 Width (mm)	 Wheel Type	 Wheel Code	 Bearing Type	 Load Capacity (kg)	 Height (mm)	 Swivel Radius	 With Brake	 Bolt Hole Size	 Swivel Code
100	35	Reb Rubber	RR4077	Ball	150	130	90	125	12	S4214
100	35	Reb Poly	RP4072	SS Roller	150	130	90	125	12	S4216
100	35	Poly Nylon	PU4408	Roller	200	130	90	125	12	S4218
100	38	Poly Ci	PU449	Ball	200	130	90	125	12	S4220
100	35	Nylon	NY401	Plain	200	130	90	125	12	S4222
100	35	Nylon	NY413	Ball	200	130	90	125	12	S4224
100	35	Glass Nylon	GF412	Plain	200	130	90	125	12	S4228* 
100	36	Aluminium	AL474	Bronze Bush	200	130	90	-	12	S4230 * 
100	36	Aluminium	AL472	Oilless Du bush	200	130	90	-	12	S4232 * 
100	38	Cast Iron	Ci421	Plain	200	130	90	125	12	S4234 * 
100	38	Cast Iron	Ci400	Ball	200	130	90	125	12	S4236 *
125	35	Reb Rubber	RR5077	Ball	200	157	112	125	12	S5214
125	35	Reb Poly	RP5072	SS Roller	200	157	112	125	12	S5216
125	35	Poly Nylon	PU5508	Roller	200	157	112	125	12	S5218
125	35	Poly Ci	PU549	Ball	200	157	112	125	12	S5220
125	35	Nylon	NY501	Plain	200	157	112	125	12	S5222
125	35	Nylon	NY513	Ball	200	157	112	125	12	S5224
150	50	Nylon	NY652	Plain	300	181	125	150	12	S6222
150	50	Nylon	NY613	Ball	300	181	125	150	12	S6224
150	45	Reb Rubber	RR6677	Ball	225	181	125	150	12	S6228
150	50	Reb Poly	RP6072	SS Roller	300	181	125	150	12	S6216



S4216



S5214



S5222

## Brake Options

B = Brake

To order castors with Brake add B to end of swivel code e.g. S4214B

\* indicates castors not available with brake

 indicates castors suitable for high/low temperature applications.

These castors have a 12mm bolt hole but can be reduced to suit a 10mm bolt with a reduction bush (top hat).

Reduction bushes available to suit 10mm fittings, code: 100RED12100BT

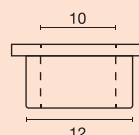
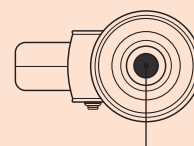

12mm hole can be reduced to 8mm or 10mm

## Castor Fitting Requirements

To fit this castor to a 20mm thick base requires a 50mm x 12mm set screw.

# 300 SERIES PLATE CASTORS

MOUNTING PLATES AVAILABLE page 70

UP TO **300KG** CAPACITY

Diameter (mm)	Width (mm)	Wheel Type	Wheel Code	Bearing Type	Load Capacity (kg)	Height (mm)	Swivel Radius (mm)	With Brake (mm)	Rigid Code	Swivel Code
100	35	Reb Rubber	RR4077	Ball	150	130	90	125	R4043	S4042
100	35	Reb Poly	RP4072	SS Roller	150	130	90	125	R4055	S4054
100	35	Poly Nylon	PU4408	Roller	200	130	90	125	R4045	S4044
100	38	Poly Ci	PU449	Ball	200	130	90	125	R4049	S4048
100	35	Nylon	NY401	Plain	200	130	90	125	R4033	S4032
100	35	Nylon	NY413	Ball	200	130	90	125	R4035	S4034
100	35	GF Nylon	GF412	Plain	200	130	90	-	R4061	S4060
100	36	Aluminium	AL474	Bronze Bush	200	130	90	-	R4067	S4066*
100	36	Aluminium	AL473	Oilless Du bush	200	130	90	-	R4059	S4058*
100	38	Cast Iron	Ci421	Plain	200	130	90	-	R4051	S4050*
100	38	Cast Iron	Ci400	Ball	200	130	90	125	R4053	S4052*
100	32	Hi-Temp Polymer	HT481	Ball	200	133	90	-	R4355	S4354*
125	35	Reb Rubber	RR5077	Ball	200	157	112	125	R5043	S5042
125	35	Reb Poly	RP5072	SS Roller	200	157	112	125	R5055	S5054
125	35	Poly Nylon	PU5508	Roller	200	157	112	125	R5045	S5044
125	35	Poly Ci	PU549	Ball	200	157	112	125	R5049	S5048
125	35	Nylon	NY501	Plain	200	157	112	125	R5033	S5032
125	35	Nylon	NY513	Ball	200	157	112	125	R5035	S5034
150	45	Reb Rubber	RR6677	Ball	225	187	127	170	R6043	S6042
150	50	Rubber	RT6642	Roller	225	187	127	170	R6041	S6040
150	50	Poly Nylon	PU6071	Ball	300	187	127	170	R6045	S6044
150	50	Nylon	NY652	Plain	300	187	127	170	R6033	S6032
150	50	Nylon	NY613	Ball	300	187	127	170	R6036	S6035
150	45	Cast Iron	Ci611	Plain	300	187	127	NA	R6051	S6050*
150	50	Reb Poly	RP6072	SS Roller	300	187	127	170	R6055	S6054
200	45	Reb Rubber	RR8871	Ball	250	237	156	170	R8043	S8042
200	50	Reb Poly	RP8072	SS Roller	250	237	156	170	R8055	S8054
200	50	Rubber	RT8842	Roller	250	237	156	170	R8041	S8040
200	45	Rubber	RN8875	Roller	200	237	156	170	R8047	S8046
200	50	Poly Nylon	PU8071	Ball	300	237	156	170	R8045	S8044
200	50	Nylon	NY800	Plain	300	237	156	170	R8033	S8032



S4216



S6048



S6032B

## Brake Options

B = Brake

To order castors with Brake add B to end of swivel code e.g. S4044B

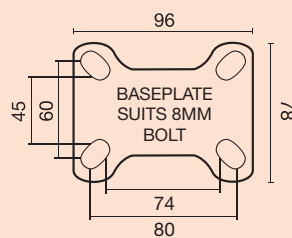

Baseplate for Rigid Castors

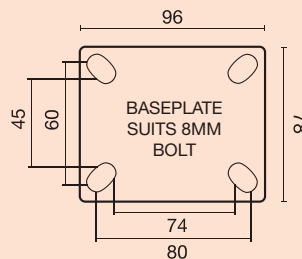

Baseplate for Swivel Castors

# indicates castors not available with directional lock.

\* indicates castors not available with brake



indicates castors suitable for high/low temperature applications.

# SELF-ALIGNING CASTOR FRAME

The self-aligning castor function is available on all 150mm and 200mm 300 series and Excel Series castors with a swivel, brake, or directional lock.

The purpose of the self-alignment function is to eliminate free spinning of the swivel castor as the wheel becomes airborne in applications such as AGV trolley transportation in hospitals, factories, warehouses and more. The castor wheel stays in its intended tracking position, then returns to full swivel function once it makes contact with the ground. This prevents the castor from becoming jammed when it returns to the ground. The self-aligning function does not affect the overall height of the castor, and can be used with conductive or anti-static wheels.

In hospitals, Automated Guided Vehicles (AGVs) are used to transport trolleys remotely – without human assistance. A location is entered into a computer system as part of a programmed mission, all of which are monitored from a control centre. AGV trolleys remove significant labour hours from each day of hospital operations, allowing staff more time to care for patients and complete other tasks.

## Here are some of the benefits of using self-aligning castors on trolleys that will be used with AGV systems:

- Keeps trolley wheels securely straight and in line while the AGV has the trolley raised from the ground
- Provides accurate and safe unloading of the trolleys
- Reduces physical strain and manual labour for employees
- Ensures maximum safety for staff
- Ensures maximum workplace efficiency
- Removes any potential hazards from outward facing wheels



The purpose of the self-alignment function is to eliminate free spinning of the swivel castor. The springs will return the castor back to default forward position.

## AGV systems have many benefits in hospitals, some of those include:

- Providing a back of house hidden transportation solution
- Removal of competition for lifts or corridor walkways – increasing efficiency
- Less maintenance and repairs to lift doors, walls and doors, frames – AGVs are more accurate and more predictable than humans
- Significant reduction in manual handling injuries and minor strains
- Enables more work to be done by less people
- Allows staff more time to care for patients and complete other tasks



# HEAVY INDUSTRIAL SERIES CASTORS

With a higher load capacity of up to 500kg, this range has been developed with strength in mind.

These castors are often seen across logistics, road transport, manufacturing and display and exhibition services.

- Largest variety of wheel types
- 6mm thick steel construction
- Available with standard baseplate or M3 baseplate
- Available with brake, directional lock, or swivel lock & brake



S5548SLB

UP TO  
**500KG**  
CAPACITY

MOUNTING  
PLATES  
AVAILABLE  
page 70

STAINLESS  
MODELS  
AVAILABLE  
page 55

Diameter (mm)	Width (mm)	Wheel Type	Wheel Code	Bearing Type	Load Capacity	Height (mm)	Swivel Radius	With Brake	Rigid Code	Swivel Code
100	35	Reb Rubber	RR4077	Ball	150	142	84	145	R4457	S4456
100	35	Reb Poly	RP4072	SS Roller	150	142	84	145	R4441	S4440
100	35	Poly Nylon	PU4408	Roller	250	142	84	145	R4438	S4437
100	38	Poly Ci	PU449	Ball	330	142	84	145	R4449	S4448
100	35	Nylon	NY401	Plain	300	142	84	145	R4434	S4433
100	35	Nylon	NY413	Ball	300	142	84	145	R4436	S4435
100	35	GF Nylon	GF412	Plain	200	142	84	145	R4455	S4454 *
100	40	High Temp Polymer	HT481	Plain	200	142	84	-	S4353	S4352 *
100	36	Aluminium	AL474	Bronze Bush	180	142	84	145	R4467	S4466 *
100	36	Aluminium	AL473	Oilless Du Bush	180	142	84	-	R4397	S4396 *
100	38	Cast Iron	Ci421	Plain	300	142	84	145	R4451	S4450 *
100	38	Cast Iron	Ci400	Ball	400	142	84	145	R4453	S4452
100	36	VG Cast Iron	VG459	Ball	280	142	84	-	R4444	S4443 *
100	50	VG Cast Iron	VG461	Roller	280	142	84	-	R4497	S4496 *
125	35	Reb Rubber	RR5077	Ball	200	165	100	145	R5545	S5544
125	35	Reb Poly	RP5072	SS Roller	200	165	100	145	R5441	S5440
125	35	Poly Nylon	PU5508	Roller	250	165	100	145	R5543	S5542
125	38	Poly Ci	PU549	Ball	330	165	100	145	R5549	S5548
125	35	Nylon	NY501	Plain	330	165	100	145	R5534	S5533
125	35	Nylon	NY513	Ball	330	165	100	145	R5536	S5535
125	38	Cast Iron	Ci532	Plain	380	165	100	145	R5551	S5550

## Brake Options

B = Brake  
D = Directional Lock

SLB = Swivel Lock & Brake











To order castors with Brake, Directional Lock or Swivel Lock & Brake add B, D or SLB to end of swivel code e.g. S5535SLB

# HEAVY INDUSTRIAL SERIES CASTORS

UP TO  
**500KG**  
CAPACITY

MOUNTING  
PLATES  
AVAILABLE  
page 70

STAINLESS  
MODELS  
AVAILABLE  
page 55

 Diameter (mm)	 Width (mm)	 Wheel Type	 Wheel Code	 Bearing Type	 Load Capacity (kg)	 Height (mm)	 Swivel Radius (mm)	 With Brake (mm)	 Rigid Code	 Swivel Code
100	50	Rubber	RT4447	Roller	110	142	84	160	R4431	S4432
100	50	Poly Nylon	PU4409	Ball	250	142	84	160	R4411	S4410
100	50	Reb Rubber	RR4078	Ball	200	142	84	160	R4371	S4370
100	50	Poly Ci	PU424	Roller	250	142	84	160	R4401	S4400
100	50	Poly Ci	PU425	Ball	500	142	84	160	R4389	S4388
100	50	PolyAlu	PU436	Ball	150	142	84	160	R4373	S4372
100	50	Poly Alu	PU407	Ball	300	142	84	145	R4275	S4274
125	50	Rubber	RT5547	Roller	180	165	100	160	R5503	S5502
125	50	Reb Rubber	RR5078	Ball	200	165	100	160	R5371	S5370
125	50	Poly Nylon	PU5509	Ball	250	165	100	160	R5511	S5510
125	50	Poly Ci	PU524	Roller	250	165	100	160	R5531	S5530
125	50	Poly Ci	PU525	Ball	500	165	100	160	S5541	S5540
125	50	PolyAlu	PU536	Ball	200	165	100	160	R5373	S5372
125	50	Poly Alu	PU507	Ball	400	165	100	145	R5275	S5274
150	45	Reb Rubber	RR6677	Ball	225	190	124	160	R6631	S6632
150	50	Rubber	RT6642	Roller	225	190	124	160	R6641	S6640
150	50	Rubber	RT6647	Roller	225	190	124	160	R6603	S6602
150	50	Reb Poly	RP6072	SS Roller	300	190	124	160	R6441	S6440
150	50	Poly Nylon	PU6071	Ball	400	190	124	160	R6645	S6644
150	50	Poly Ci	PU614	Roller	250	190	124	160	R6656	S6655
150	50	Poly Ci	PU649	Ball	500	190	124	160	R6649	S6648
150	50	Nylon	NY652	Plain	400	190	124	160	R6634	S6633
150	50	Nylon	NY613	Ball	400	190	124	160	R6636	S6635
150	50	GF Nylon	GF652	Plain	400	190	124	160	R6625	S6624 *
150	50	VG Cast Iron	VG661	Roller	400	190	124	160	R6697	S6696 *
150	45	Cast Iron	Ci611	Plain	500	190	124	160	R6651	S6650
150	45	Cast Iron	Ci601	Ball	500	190	124	160	R6653	S6652
150	50	PolyAlu	PU636	Ball	200	190	124	160	R6627	S6626
150	50	Poly Alu	PU607	Ball	500	190	124	160	R6275	S6274



S5530



S6632SLB



S6274

\* indicates castors not available with brake



indicates castors suitable for high/low temperature applications.

# HEAVY INDUSTRIAL SERIES CASTORS

UP TO  
**600KG**  
CAPACITY

MOUNTING  
PLATES  
AVAILABLE  
page 70

STAINLESS  
MODELS  
AVAILABLE  
page 55



S8851



R8850



S8855

Diameter (mm)	Width (mm)	Wheel Type	Wheel Code	Bearing Type	Load Capacity (kg)	Height (mm)	Swivel Radius (mm)	With Brake (mm)	Rigid Code	Swivel Code
200	45	Reb Rubber	RR8871	Ball	250	241	156	160	<b>R8831</b>	<b>S8832</b>
200	35	Rubber	RN8875	Roller	200	241	156	160	<b>R8873</b>	<b>S8872</b>
200	50	Rubber	RT8842	Roller	250	241	156	160	<b>R8841</b>	<b>S8840</b>
200	50	Rubber	RT8847	Roller	250	241	156	160	<b>R8803</b>	<b>S8802</b>
200	50	Poly Nylon	PU8071	Ball	400	241	156	160	<b>R8850</b>	<b>S8849</b>
200	50	Poly Ci	PU849	Ball	500	241	156	160	<b>R8852</b>	<b>S8851</b>
200	50	Nylon	NY800	Plain	400	241	156	160	<b>R8844</b>	<b>S8843</b>
200	50	Cast Iron	CI842	Plain	380	241	156	160	<b>R8854</b>	<b>S8853</b>
200	50	Cast Iron	CI852	Ball	500	241	156	160	<b>R8856</b>	<b>S8855</b>
200	50	Nylon	NY830	Ball	400	241	156	160	<b>R8846</b>	<b>S8845</b>
200	50	PolyAlu	PU815	Ball	250	241	156	160	<b>R8825</b>	<b>S8824</b>
200	50	Poly Alu	PU807	Ball	500	241	156	160	<b>R8275</b>	<b>S8274</b>

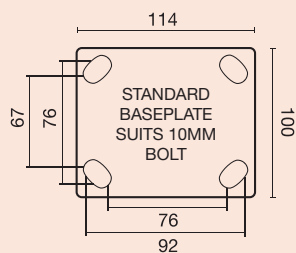

Baseplate dimensions and drilling patterns for Heavy Industrial series castors

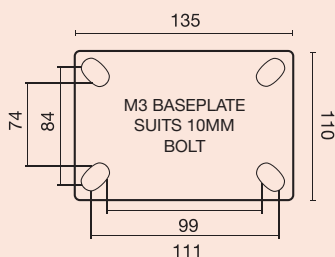

Available with a standard baseplate or M3 (Metric) baseplate

# PNEUMATIC & PUNCTURE PROOF SERIES CASTORS

These castors are ideal for outdoor use over soft or hard ground, with quality rubber tyres providing a cushioned ride.

These castors are the best choice for use on agricultural equipment and for sports equipment such as batting cages, nets and equipment trolleys.

- Pneumatic or puncture proof rubber tyres
- Sealed bearings
- Available with brake













S8861











UP TO  
**180KG**  
CAPACITY

MOUNTING  
PLATES  
AVAILABLE  
page 70

## PNEUMATIC WHEEL CASTORS

 Diameter (mm)	 Width (mm)	 Wheel Type	 Wheel Code	 Bearing Type	 Load Capacity (kg)	 Height (mm)	 Swivel Radius (mm)	 Rigid Code	 Swivel Code
160	50	Pneumatic	PN6200	Ball	60	191	-	-	S6201
160	50	Pneumatic	PN6200	Ball	60	197	-	R6002	S6001
160	50	Pneumatic	PN6200	Ball	60	200	-	R6662	S6661
220	60	Pneumatic	PN8860	Ball	100	260	160	R8862	S8861
260	85	Pneumatic	PN1066	Ball	180	315	200	R1068	S1067

## PUNCTURE PROOF WHEEL CASTORS

 Diameter (mm)	 Width (mm)	 Wheel Type	 Wheel Code	 Bearing Type	 Load Capacity (kg)	 Height (mm)	 Swivel Radius (mm)	 Rigid Code	 Swivel Code
215	55	Puncture Proof	PF8881	Ball	50	245	160	R8835	S8834
260	83	Puncture Proof	PF1084	Ball	50	305	200	R1089	S1088



WHEELS ALL HAVE SEALED PRECISION BALL BEARINGS FOR LONG LIFE.

## Brake Options

B = Band Brake

To order castors with Brake add B to end of swivel code e.g. S8861B

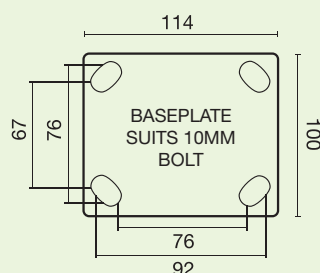

Baseplate dimensions and drilling patterns for Pneumatic/Puncture Proof castors



S1088B

# HEAVY DUTY WELDED SERIES CASTORS

This range is precision built for use under extreme working conditions where a low profile, high load bearing castor is required.











A precision machines swivel ball race provides a smooth swivel action, while a kingpin made of high tensile steel can withstand high side impact loads.

- Nylon, cast iron, or polyurethane centred cast iron wheels
- Stainless steel frames available
- Australian made forks



S547



 Diameter (mm)	 Width (mm)	 Wheel Type	 Wheel Code	 Bearing Type	 Load Capacity (kg)	 Height (mm)	 Swivel Radius (mm)	 Rigid Code	 Swivel Code
75	25	Poly Ci	PU350	Ball	240	114	76	R328	S327
75	30	Nylon	NY3321	Plain	125	114	76	R321	S323
100	38	Poly Ci	PU449	Ball	330	132	90	R448	S447
100	35	Nylon	NY401	SS Sleeve	300	132	90	R402	S406
100	35	Nylon	NY413	Ball	300	132	90	R415	S416
100	35	Cast Iron	CI421	Plain	300	132	90	R423	S422
100	38	Cast Iron	Ci400	Ball	400	132	90	R440	S470
100	36	Cast Iron	VG459	Ball	280	132	90	R466	S465
125	35	Poly Ci	PU549	Ball	330	159	102	R548	S547
125	35	Nylon	NY501	SS Sleeve	330	159	102	R502	S506
125	35	Nylon	NY513	Ball	330	159	102	R515	S516
125	38	Cast Iron	Ci532	Plain	380	159	102	R534	S533



S323



R534

## Brake Options

B = Brake  
D = 4 Way Directional Lock

To order castors with Brake or 4 Way Directional Lock or Swivel Lock & Brake add B or D to end of swivel code e.g. S442B

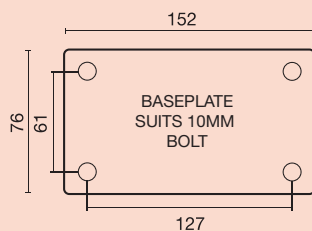

Baseplate dimensions & drilling patterns for Heavy Duty Welded castors

 indicates castors suitable for high/low temperature applications.

Optional baseplate sizing available. Contact us to find out more.

# WASTE BIN CASTORS & SETS

UP TO  
**500KG**  
CAPACITY

These castors are built to withstand the tough conditions of waste management.

Frequently seen on bulk bins and skips, this range features a heavy duty cast iron steel center for the heaviest of loads.

- SG Iron, rubber cast iron and polyurethane cast iron wheels
- Heavy duty
- Available in sets

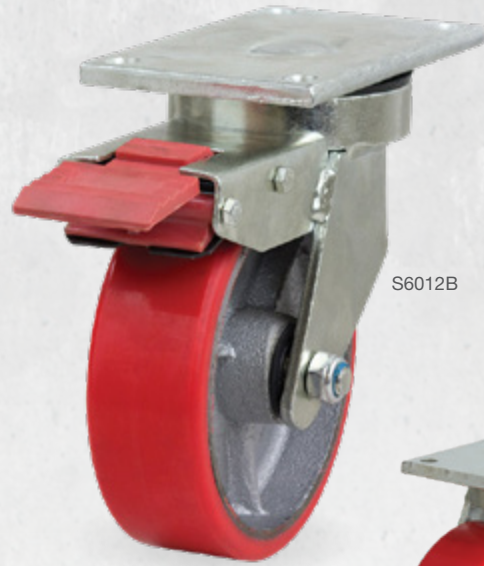

S6012B



S6012

## WASTE BIN CASTORS

Diameter (mm)	Wheel Type	Bearing Type	Height (mm)	Load Capacity (kg)	Wheel Code	Rigid Code	Swivel Code
150	SG Iron	Plain	194	500	SG607	R6011	S6010
150	Rubber Ci	Roller	194	250	RT6647	R6015	S6014
150	Poly Ci	Roller	194	250	PU614	S6013	S6012

## COMPLETE WASTE BIN CASTOR SETS

Diameter (mm)	Swivel Qty	Swivel Brake Qty	Swivel, Lock & Brake Qty	Rigid Qty	Wheel Type	Bearing Type	Waste Set Code
150	2	-	-	2	SG Iron	Plain	WASTESETT
150	2	-	-	2	Rubber Ci	Roller	WASTESETT-2
150	4	-	-	-	SG Iron	Plain	WASTESETT-3
150	2	-	-	2	Poly Ci	Roller	WASTESETT-5
150	-	-	2	2	Poly Ci	Roller	WASTESETT-7
150	1	-	1	2	SG Iron	Plain	WASTESETT-8
150	-	2	-	2	SG Iron	Plain	WASTESETT-9
150	-	2	-	2	Poly Ci	Roller	WASTESETT-10
150	4	-	-	-	Poly Ci	Roller	WASTESETT-12
150	-	-	2	2	Rubber Ci	Roller	WASTESETT-13



S6010B

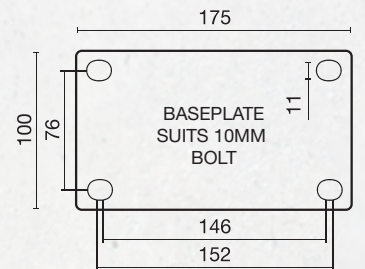

Baseplate dimensions & drilling patterns for Waste Bin castors

## CASTORS TO SUIT 660 & 1100L PLASTIC WHEELIE BINS

Diameter (mm)	Wheel Type	Height (mm)	Load Capacity (kg)	Swivel Code
200	Rubber	245	200	S8064



S8064

Also available with brake (S8064B) or directional lock (S8064D)

# 500 SERIES CASTORS

This range has been designed and manufactured for heavy duty applications including low speed, medium weight towing up to 6kph.













These castors are suitable for industries such as automotive, steel manufacturing and rapid production lines.

- Large variety of wheel types
- Sealed precision machined ball race
- Heavy duty



S6270SLB



 Diameter (mm)	 Width (mm)	 Wheel Type	 Wheel Code	 Bearing Type	 Load Capacity (kg)	 Height (mm)	 Swivel Radius (mm)	 Rigid Code	 Swivel Code
100	50	Poly/Alum	PU407	Ball	300	139	108	R4247	S4246
100	50	Poly Ci	PU425	Ball	500	139	108	R4271	S4270 *
100	50	Steel	ST464	Ball	500	139	108	R4861	S4860 *
125	45	Steel	CI520	Ball	500	166	108	R5211	S5210 *
125	50	Poly/Alum	PU507	Ball	400	166	120	R5247	S5246
125	50	Poly Ci	PU525	Ball	500	166	132	R5271	S5270 *
150	50	Rubber	RT6642	Roller	300	194	130	R6761	S6760
150	50	Poly Nylon	PU6071	Ball	400	194	130	R6215	S6214
150	50	Poly/Alum	PU607	Ball	500	194	130	R6021	S6020
150	50	Poly Ci	PU614	Roller	250	194	130	R6013	S6012
150	50	Poly Ci	PU649	Ball	500	194	130	R6271	S6270 
150	50	Nylon	NY652	SS Sleeve	400	194	130	R6061	S6060
150	50	Nylon	NY613	Ball	400	194	130	R6121	S6120
150	45	Cast Iron	CI1611	Plain	500	194	130	R6711	S6710! 
150	45	Cast Iron	CI1601	Ball	500	194	130	R6241	S6240!
150	38	Vg Cast Iron	VG609	Ball	500	194	130	R6451	S6450 *
150	50	Poly/Alum	PU636	Ball	200	194	130	R6017	S6016

## Brake Options

SLB = Swivel Lock & Brake

D = 4 Way Directional Lock

To order castors with Brake or 4 Way Directional Lock or Swivel Lock & Brake add SLB or D to end of swivel code e.g. S6214SLB

 indicates towable castors

 indicates castors suitable for high/low temperature applications.

\* indicates castors not available with brake















! indicates castors available with wheel brake only

# 500 SERIES CASTORS

MOUNTING  
PLATES  
AVAILABLE  
page 70

UP TO  
**500KG**  
CAPACITY



 Diameter (mm)	 Width (mm)	 Wheel Type	 Wheel Code	 Bearing Type	 Load Capacity (kg)	 Height (mm)	 Swivel Radius	 Rigid Code	 Swivel Code
200	45	Reb Rubber	RR8871	Ball	350	248	155	<b>R8071</b>	<b>S8070</b>
200	50	Poly/Alum	PU807	Ball	500	248	155	<b>R8021</b>	<b>S8020</b>
200	50	Rubber	RT8842	Roller	250	248	155	<b>R8231</b>	<b>S8230</b>
200	50	Poly Nylon	PU8071	Ball	400	248	155	<b>R8215</b>	<b>S8214</b>
200	50	Poly/Alum	PU815	Ball	250	248	155	<b>R8261</b>	<b>S8260</b>
200	50	Poly Ci	PU849	Ball	500	248	155	<b>R8471</b>	<b>S8470</b> 
200	50	Nylon	NY800	SS Sleeve	400	248	155	<b>R8281</b>	<b>S8280</b>
200	50	Nylon	NY830	Ball	400	248	155	<b>R8121</b>	<b>S8120</b>
200	50	Cast Iron	CI842	Plain	500	248	155	<b>R8451</b>	<b>S8450 !</b> 
200	50	Cast Iron	CI852	Ball	500	248	155	<b>R8431</b>	<b>S8430 !</b>
200	52	V-Groove	VG839	Ball	500	248	155	<b>R8507</b>	<b>S8506 *</b>
230	40	Cushion Rubber	CR9000	Ball	220	294	175	<b>R9011</b>	<b>S9010</b> 
250	50	Cushion Rubber	CR1060	Ball	300	302	180	<b>R1026</b>	<b>S1025</b> 
250	50	Poly Ci	PU1056	Ball	500	302	180	<b>R1052</b>	<b>S1051</b> 

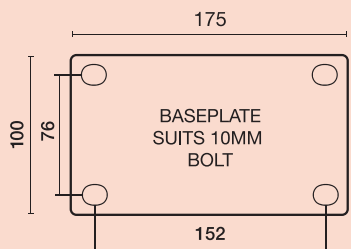

Baseplate dimensions & drilling patterns for 500 series castors



# 1000 SERIES CASTORS

A higher load capacity of up to 1000kg per castor makes this range suitable for mobile platforms, aviation trolleys, automotive assembly lines and production manufacturing plants.

These castors have the ability to be towed at 6kph by tugs and tractors.

- Cast iron and poly tyred cast iron wheels
- High tensile steel kingpin to withstand side impact loads



S6338SLB



Diameter (mm)	Width (mm)	Wheel Type	Wheel Code	Bearing Type	Load Capacity (kg)	Height (mm)	Swivel Radius (mm)	Rigid Code	Swivel Code	
150	50	Poly Ci	PU659	Ball	900	194	130	<b>R6339</b>	<b>S6338</b>	⊙
150	45	Cast Iron	Ci601	Ball	1000	194	130	<b>R6319</b>	<b>S6318</b>	
200	50	Poly Ci	PU876	Ball	1000	248	155	<b>R8069</b>	<b>S8068</b>	⊙
200	50	Cast Iron	Ci852	Ball	1000	248	155	<b>R8089</b>	<b>S8088</b>	
250	50	Poly Ci	PU1056	Ball	1000	300	180	<b>R1020</b>	<b>S1019</b>	⊙
300	50	Poly Ci	PU1218	Ball	1000	360	215	<b>R1205</b>	<b>S1204</b>	⊙

## Brake Options

B = Brake  
D = Directional Lock  
SLB = Swivel Lock & Brake

To order castors with Brake or 4 Way Directional Lock or Swivel Lock & Brake add B, SLB or D to end of swivel code e.g. S8088B

⊙ indicates towable castors

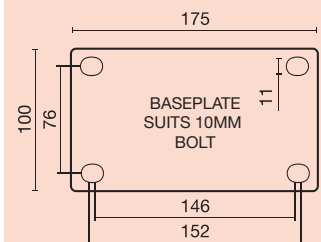

Baseplate dimensions & drilling patterns for 1000 Series Castors



R6319



S1019

# FORGED HEAD SERIES CASTORS

Applications including transport and logistics, heavy machinery, warehousing equipment and mobile platforms rely on the extreme shock loading, robust durable kingpin and drop forged steel baseplate of Richmond's Forged Head Series for loads up to 1500kg.

They are a great choice for heavy duty applications requiring a towable option.

- Polyurethane, SG iron, or solid pneumatic wheels
- Drop forged steel baseplate



Diameter (mm)	Width (mm)	Wheel Type	Wheel Code	Bearing Type	Load Capacity (kg)	Height (mm)	Swivel dius	Rigid Code	Swivel Code	
200	75	Poly	PU824	Ball	2000	268	156	R8003	S8002	👤
200	75	SG Iron	SG822	Ball	2000	268	156	R8001	S8000	
250	75	Poly	PU1030	Ball	2000	317	194	R1035	S1034	👤
250	75	SG Iron	SG1027	Ball	2000	317	194	R1033	S1032	
250	75	Solid PN	SN1005	Ball	260	317	194	R1045	S1044	👤
300	75	Poly	PU1217	Ball	2000	370	234	R1235	S1234	👤
300	75	Solid PN	SN1295	Ball	540	370	234	R1245	S1244	👤

## Brake Options

B = Brake  
D = Directional Lock

To order castors with Brake or Directional Lock add B or D to end of swivel code e.g. S1044B

👤 indicates towable castors

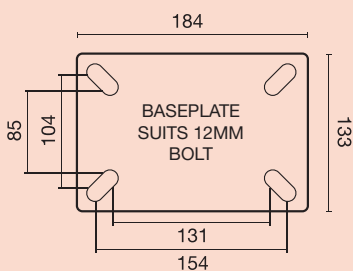

Baseplate dimensions & drilling patterns for Forged Head Series castors



S1034



R1033

# KINGPINLESS CASTORS









Richmond's kingpinless castors give you the best combination of brute strength with easy maneuverability and rollability. With a choice of Solid Black Nylon or Poly-Tyred Cast Iron Centred wheels with swivel, rigid and brake options these are also one of our most versatile, high-capacity castor series available.

A kingpinless castor is made up of fewer components which therefore requires less maintenance and is suitable for high loads.









The castor's load is also spread over a larger area and swivels more freely.



## BLACK NYLON WHEEL KINGPINLESS CASTORS

 Diameter (mm)	 Width (mm)	 Wheel Type	 Wheel Code	 Bearing Type	 Load Capacity	 Height (mm)	 Rigid Code	 Swivel Code
150	50	Solid Nylon	NY617	Ball	1800	190	<b>R6153</b>	<b>S6152</b>

## POLYURETHANE TYRED CAST IRON CENTRED KINGPINLESS CASTORS

 Diameter (mm)	 Width (mm)	 Wheel Type	 Wheel Code	 Bearing Type	 Load Capacity	 Height (mm)	 Rigid Code	 Swivel Code
150	50	Poly Ci	PU619	Ball	1800	190	<b>R6155</b>	<b>S6154</b>

### Brake Options

B = Wheel Brake Only

To order castors with a Brake add B to end of swivel code e.g. S6154B

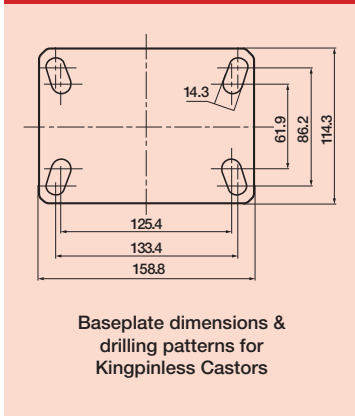

S6152B

# 3000 SERIES CASTORS



This extra heavy-duty range has been precisely engineered to excel under the hardest conditions.

These castors have increased towing capacity and towing speed.

- Polyurethane, SG iron, pneumatic, or solid pneumatic wheels
- Increased towing capacity



S10902



S8904

Diameter (mm)	Width (mm)	Wheel Type	Wheel Code	Bearing Type	Load Capacity	Height (mm)	Swivel Radius	Rigid Code	Swivel Code	
200	76	Poly	PU823	Ball	3000	260	167	R8905	S8904	
200	76	SG Iron	SG834	Ball	3000	260	167	R8903	S8902	
250	76	Poly	PU1029	Ball	3000	310	190	R10905	S10904	
250	76	SG Iron	SG1040	Ball	3000	310	190	R10903	S10902	
250	70	Solid Pneumatic	SN1005	Ball	260	310	190	R10909	S10908	
250	100	Poly	PU1048	Ball	3000	310	190	R10913	S10912	
300	76	Poly	PU1217	Ball	3000	364	228	R12905	S12904	
300	85	Solid Pneumatic	SN1295	Ball	550	364	228	R12909	S12908	
300	100	Poly	PU1224	Ball	3000	364	228	R12913	S12912	
400	100	Solid Pneumatic	SN1612	Ball	950	462	293	R16901	S16902	
400	100	Pneumatic	PN1616	Ball	300	462	293	R16903	S16904	

## Brake Options

B = Brake  
D = 4 Way Directional Lock

To order castors with Brake or 4 Way Directional Lock add B or D to end of swivel code e.g. S8904B

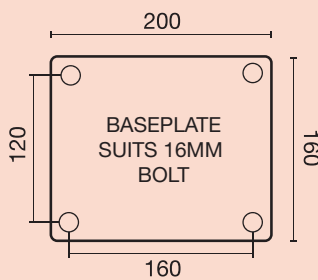

Standard baseplate dimensions and drilling patterns for 3000 Series castors

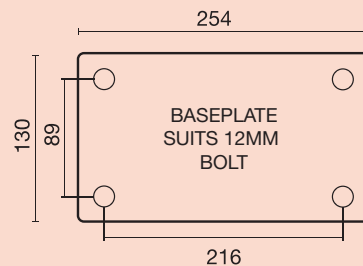

Optional baseplate dimensions & drilling patterns for 3000 Series castors. Add OP to the end of the castor code to specify Optional Baseplate e.g. s8904OP

indicates towable castors

## CUSTOM DESIGNED & MANUFACTURED IN MELBOURNE

This range is designed and made to order in Melbourne by our in-house engineering team.

## DESIGN ALTERATIONS AVAILABLE

Contact our team about tailoring this product to your requirements.

# HIGH PERFORMANCE SERIES CASTORS

These heavy-duty castors are designed with endurance and performance in mind.

They feature large opposed taper roller bearings in the swivel head, which allow for the castors to be power-towed at speeds of up to 12kph. The frames are robot welded and fully sealed to ensure a long lifespan. They are designed and custom manufactured in-house.

- Polyurethane cast-iron, cast iron, pneumatic, or solid-pneumatic wheels available
- Power-towing up to 12kph

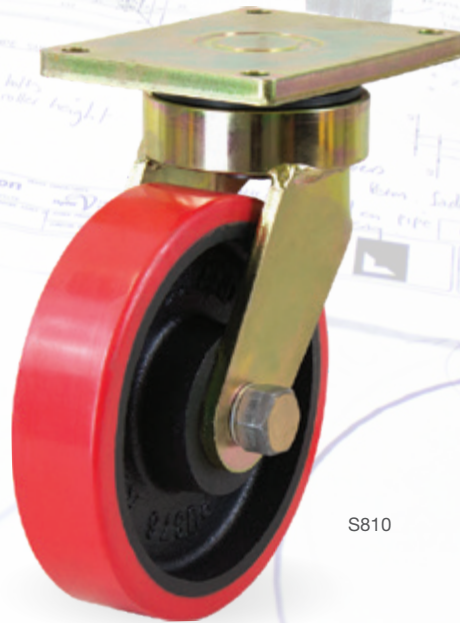

S810

UP TO  
**1500KG**  
CAPACITY

**CUSTOM DESIGN**

Diameter (mm)	Width (mm)	Wheel Type	Wheel Code	Bearing Type	Load Capacity (kg)	Height (mm)	Swivel Radius (mm)	Rigid Code	Swivel Code	
150	50	Poly Ci	PU659	Ball	900	214	135	R634	S633	☺
150	75	Poly Ci	PU615	Ball	1100	214	135	R656	S657	
150	45	Cast Iron	Ci601	Ball	1500	214	135	R632	S631	
150	75	Cast Iron	Ci689	Ball	1500	214	135	R691	S690	
200	50	Poly Ci	PU876	Ball	1200	264	172	R811	S810	☺
200	50 x 2	TW Poly Ci	PU876	Ball	1200	264	172	R873	S872	☺
200	75	Poly Ci	PU896	Ball	1300	264	172	R898	S897	☺
200	50	SG Iron	SG835	Ball	1500	264	172	R819	S818	
200	75	SG Iron	SG834	Ball	1500	264	172	R838	S837	
250	75	Poly Ci	PU1076	Ball	1300	312	210	R1018	S1017	☺
250	75 x 2	TW Poly Ci	PU1076	Ball	1300	312	210	R1091	S1090	☺
250	75	SG Iron	SG1040	Ball	1500	312	210	R1042	S1043	
300	75	Poly Ci	PU1217	Ball	1500	375	240	R1229	S1228	☺
300	100	Poly Ci	PU1224	Ball	1500	375	240	R1226	S1225	☺
400	100	Pneumatic	PN1616	Ball	300	475	295	R1602	S1601	☺
400	100	Solid Pneumatic	SN1612	Ball	950	475	295	R1649	S1650	☺



S818



S1043

## Brake Options

B = Brake  
D = 4 Way Directional Lock

To order castors with Brake or 4 Way Directional Lock add B or D to end of swivel code e.g. S633B

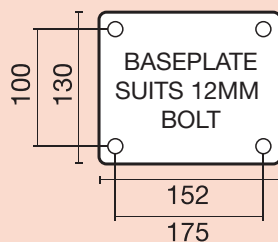

Standard High Performance Series baseplate

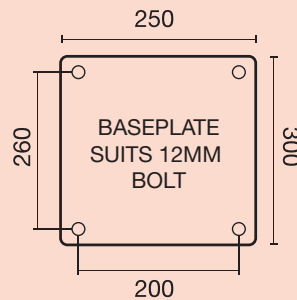

Standard twin wheel rigid baseplate

☺ indicates towable castors

# EXTRA HIGH PERFORMANCE SERIES CASTORS

UP TO  
**5000KG**  
CAPACITY

**CUSTOM**  
DESIGN

This range of castors can carry a huge load capacity of up to 5000kg per castor.

They feature large opposed taper roller bearings in the swivel head, which allow for the castors to be power-towed at speeds of up to 12kph. The frames are robot welded and fully sealed to ensure a long lifespan. They are designed and custom manufactured in-house.

- Steel, polyurethane steel, or polyurethane cast iron wheels
- Power-towing up to 12kph



S1093B

Diameter (mm)	Width (mm)	Wheel Type	Wheel Code	Bearing Type	Load Capacity (kg)	Height (mm)	Swivel Radius (mm)	Rigid Code	Swivel Code	
200	75	steel	ST836	Taper	5000	320	172	<b>R865</b>	<b>S866</b>	●
200	84	poly/steel	PU890	Taper	5000	320	172	<b>R893</b>	<b>S894</b>	●
250	100	Poly Ci	PU1049	Taper	5000	370	210	<b>R1092</b>	<b>S1093</b>	●
300	100	Poly Ci	PU1224	Ball	3000	420	240	<b>R1221</b>	<b>S1222</b>	●
300	100	Poly Ci	PU1203	Taper	5000	420	240	<b>R1223</b>	<b>S1224</b>	●
400	125	Poly Ci	PU1606	Taper	5000	520	295	<b>R1607</b>	<b>S1608</b>	●

## Brake Options

B = Brake  
D = 4 Way Directional Lock

To order castors with Brake or 4 Way Directional Lock add B or D to end of swivel code e.g. S886B

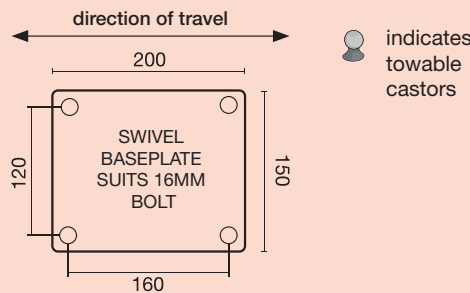

Standard baseplate dimensions and drilling patterns for EHP castors



S1093

## CUSTOM DESIGNED & MANUFACTURED

This range is designed and made to order by our in-house engineering team.

## DESIGN ALTERATIONS AVAILABLE

Contact our team about tailoring this product to your requirements.

# EXTRA HIGH PERFORMANCE TWIN WHEEL CASTORS

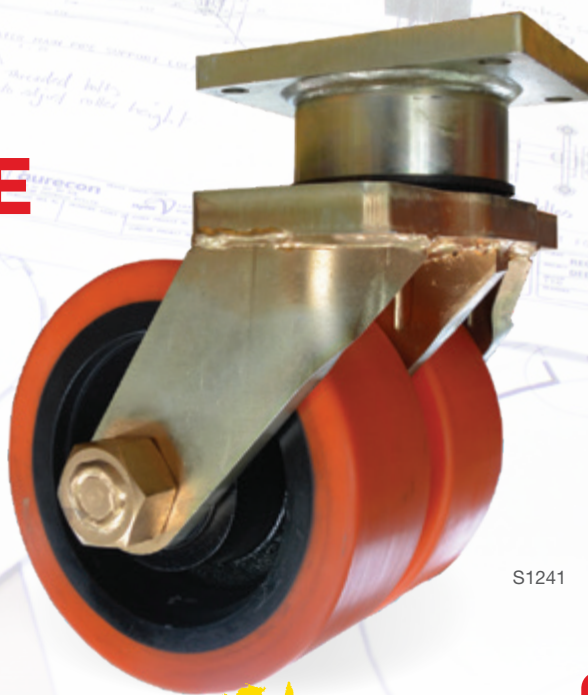















S1241

The twin-wheel design of this range allows for even higher power-towing capabilities of 16kph on flat surfaces without obstacles.

They feature large opposed taper roller bearings in the swivel head, and a robot welded swivel head to ensure a long lifespan. They are designed and custom manufactured in-house.

- 2 x polyurethane tyred cast iron wheels
- Twin wheel design increases surface contact and controls rolling speed of each wheel when turning and manoeuvring
- Power-towing of up to 16kph



 Diameter (mm)	 Width (mm)	 Wheel Type	 Wheel Code	 Bearing Type	 Load Capacity (kg)	 Height (mm)	 Swivel Radius (mm)	 Rigid Code	 Swivel Code	
250	50 x 2	TW Poly Ci	PU1061 x 2	Taper	3000	370	210	R1062	S1063	
250	75 x 2	TW Poly Ci	PU1076 x 2	Taper	3000	370	210	R1064	S1065	
300	50 x 2	TW Poly Ci	PU1218 x 2	Taper	3000	420	240	R1236	S1237	
300	100 x 2	TW Poly Ci	PU1203 x 2	Taper	5000	420	240	R1240	S1241	

## Brake Options

- B = Brake
- D = 4 Way Directional Lock

To order castors with Brake or 4 Way Directional Lock add B or D to end of swivel code e.g. S1068B

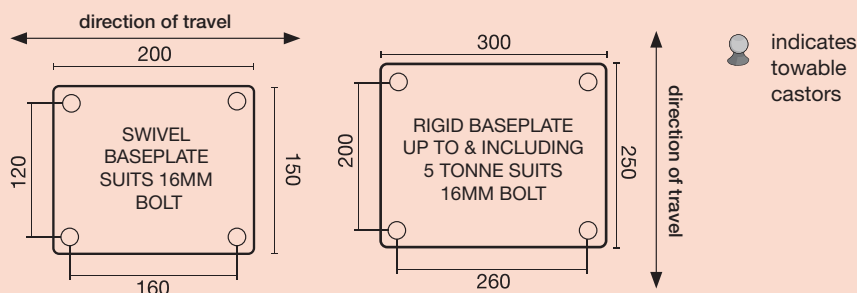

Standard baseplate dimensions & drilling patterns for Twin Wheel EHP castors

### CUSTOM DESIGNED & MANUFACTURED

This range is designed and made to order by our in-house engineering team.

### DESIGN ALTERATIONS AVAILABLE

Contact our team about tailoring this product to your requirements.

# 10 TONNE CASTORS

This castor range has the ability to carry loads of up to 10,000kg.

They are custom designed and manufactured in-house, and are typically used in extreme high-capacity applications across construction, mining, and defence.

- 2 x polyurethane cast iron or 2 x steel wheels
- Extreme high-capacity

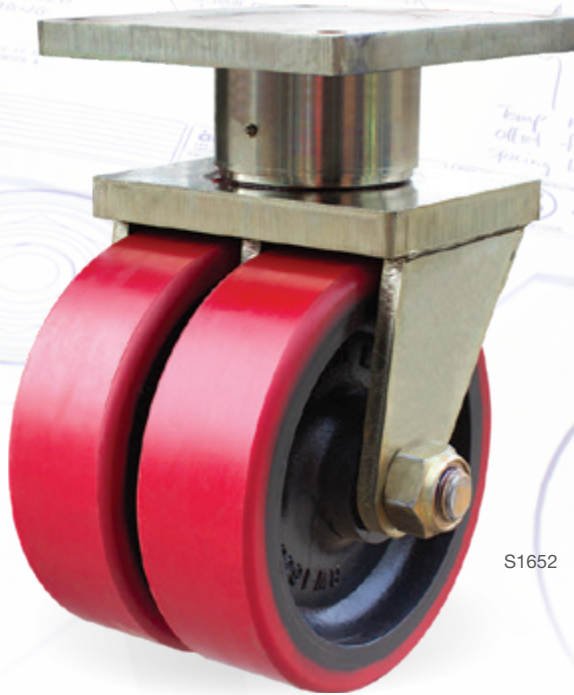

S1652

**UP TO 10T CAPACITY**

**CUSTOM DESIGN**

Diameter (mm)	Width (mm)	Wheel Type	Wheel Code	Bearing Type	Load Capacity (kg)	Height (mm)	Swivel Radius (mm)	Rigid Code	Swivel Code
400	125x2	TW Poly Ci	PU1606	Taper	10,000	610	318	<b>R1653</b>	<b>S1652</b>
400	125x2	TW Steel Wheel	ST1606	Taper	10,000	610	318	<b>R1645</b>	<b>S1644</b>

## Brake Options

B = Brake  
D = Directional Lock

To order castors with Brake or Directional Lock add B or D to end of swivel code e.g. S1044B

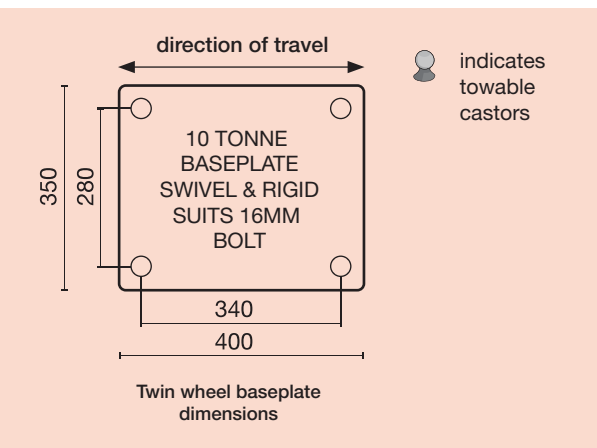

R1653

### CUSTOM DESIGNED & MANUFACTURED

This range is designed and made to order by our in-house engineering team.

### DESIGN ALTERATIONS AVAILABLE

Contact our team about tailoring this product to your requirements.

# SHIPPING CONTAINER CASTOR MOUNTING PLATES

These mounting plates allow castors to be attached to shipping containers. Fitting requires using two left-hand and two right-hand mounting plates.

When used with our **3000 Series castors**, the shipping container may have a maximum total loading of 12T, and can be towed at a maximum of 8kph.

When used with our **Extra High Performance Series castors**, the shipping container may have a maximum total loading of 20T, and can be towed at a maximum of 12kph.

As shipping containers have 2 left fittings and 2 right fittings, 2 x 195CONT-LOCKITL and 2 x 195CONT-LOCKITR must be ordered in addition to your 4 chosen castors.



## KIT CONTENTS

- 1 x Left or right corner fitting
- 1 x Locating bush
- 1 x M30 bolt
- 1 x Flat washer
- 4 x M30 Spring washers & fasteners

\*Castors sold separately



195CONT-LOCKITL a left side container mounting plate

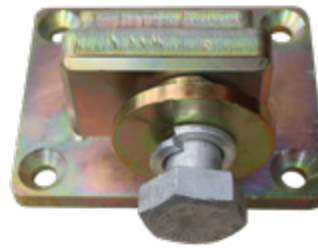

195CONT-LOCKITR a right side container mounting plate

To move a container order **2 x 195CONT-LOCKITL, 2 x 195CONT-LOCKITR + 4 castors.**



5000kg capacity mount using Extra High Performance Series



3000kg capacity mount using 3000 Series Castor

## CUSTOM DESIGNED & MANUFACTURED

This range is designed and made to order by our in-house engineering team.

# TOWMASTER SERIES CASTORS



**UP TO  
2250KG  
CAPACITY**

**CUSTOM  
DESIGN**

These castors are suitable for towing speeds of up to 24kph, and were initially designed for airport ground support dollies. They are also seen in container handling areas, wharves and manufacturing plants.

- Twin wheel solid pneumatic wheels
- Ideal for tarmac use
- Richmond offers a full maintenance and service program on this castor series

Diameter (mm)	Width (mm)	Wheel Type	Wheel Code	Bearing Type	Load Capacity (kg)	Height (mm)	Swivel Radius (mm)	Rigid Code	Swivel Code
406	125 x 2	TW Solid Pneumatic	SN1619 x 2	Ball	2250	460	322	<b>R1625</b>	<b>S1624</b>
406	125 x 2	TW Solid Pneumatic	SN1615 x 2	Ball	2250	460	322	<b>R1623</b>	<b>S1622</b>

## Brake Options

B = Brake    D = 4-Way Directional Lock

To order castors with Brake or 4-Way Directional Lock add B or D to end of swivel code e.g. S1622B

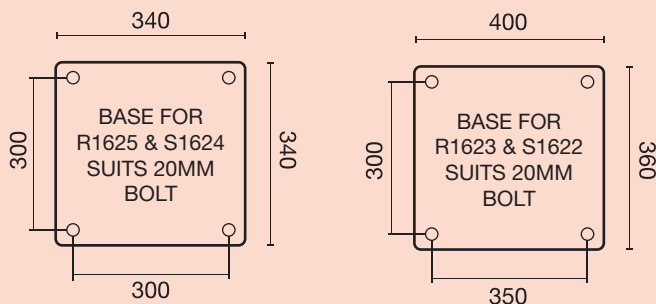

**Alternative/replacement Towmaster castors suitable for fully imported ground support container trailers are available (R1639 & S1638).**

These castors fit directly to the trolley and are backed by Richmond's service and spare parts program.

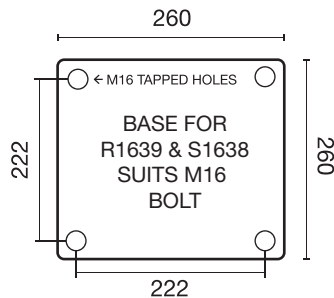

## CUSTOM DESIGNED & MANUFACTURED

This range is designed and made to order by our in-house engineering team.



# AVIATION PRODUCTS

Richmond offers a vast range of spare parts to suit all makes and models of airport ground support trailers and commander loaders.

Using our inhouse polyurethane moulding facilities, we can recoat worn-out rubber coated Commander castor wheels and drive rollers with a much longer lasting, harder wearing poly material.

Please contact our team for more information.

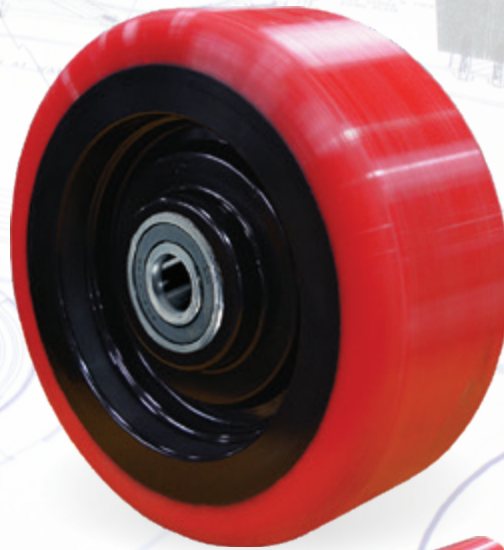

PU1209  
Commander  
Wheel









Richmond Cargo Castors at work in Airport cargo handling systems



Commander  
Rollers

## CARGO SERIES CASTORS

 Diameter (mm)	 Wheel Width (mm)	 Wheel Type	 Bearing Type	 Load Capacity (kg)	 Height (mm)	 Swivel Code
58	35	Nylon	Ball	200	96	S2334
70	35	Nylon	Ball	200	102	S2446



S2334



**Replacement Swivel & Rigid Frames**

**Replacement Steel Rims**

**Replacement Cushion Solid Tyres**

**Replacement Steel Rollers**

## CUSTOM DESIGNED & MANUFACTURED

This range is designed and made to order by our in-house engineering team.

# SPRING LOADED SHOCK-ABSORBING CASTORS

These castors have been designed to reduce the impact of shocks during transport. They provide smoother movement, a reduced risk of damage and a quieter ride.

This range is ideal for use in applications on uneven surfaces, where debris are present or when moving delicate items.

- Poly cast iron wheels
- Spring absorbs impact



Diameter (mm)	Wheel Width	Wheel Type	Bearing Type	Load Capacity (kg)	Height (mm)	Swivel Radius (mm)	Rigid Code	Swivel Code
100	50	Poly Ci	Ball Bearing	200	180	105	R4089	S4088
125	50	Poly Ci	Ball Bearing	200	194	119	R5089	S5088
150	50	Poly Ci	Ball Bearing	200	205	130	R6089	S6088
200	50	Poly Ci	Ball Bearing	200	256	181	R8099	S8089

## Brake Options

B = Brake

To order castors with Brake add B to end of swivel code e.g. S6088B

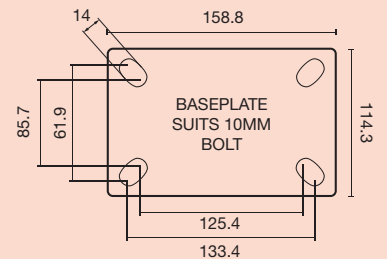
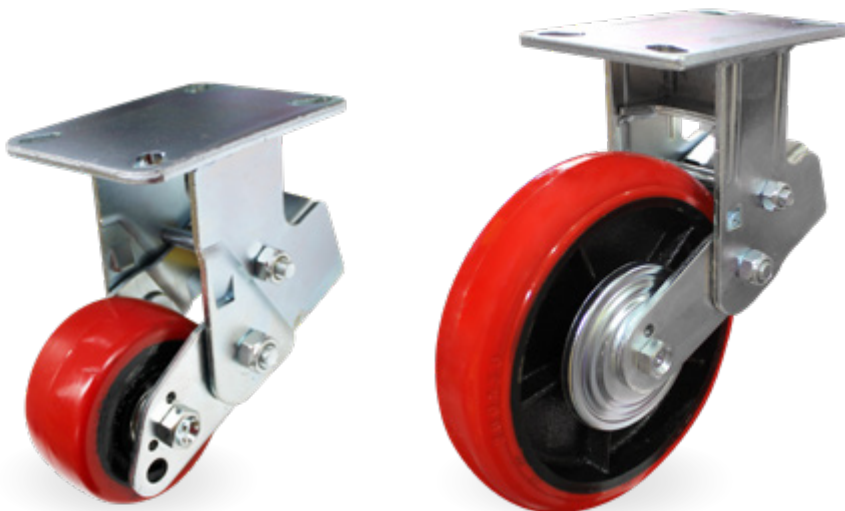

Baseplate dimensions & drilling patterns for Shock-Absorbing castors

# HIGH/LOW TEMP CASTORS

This range of castors are designed for temperature fluctuation and exposure from -30° to +350° with peaks of up to 400°C.

Featuring castors from across Richmond's entire range, these high and low temperature castors are frequently seen in bakery applications, smoke houses and chillers.

- Wide range of wheel types
- Suitable for temperature ranges from -30° to +350°



S4354

View our full range of high/low temperature wheels on page 91

Diameter (mm)	Width (mm)	Wheel Type	Wheel Code	Bearing Type	Load Capacity (kg)	Height (mm)	Swivel Radius (mm)	Temperature range (°C)	Rigid Code	Swivel Code
---------------	------------	------------	------------	--------------	--------------------	-------------	--------------------	------------------------	------------	-------------

## LIGHT INDUSTRIAL SERIES - PLATE MOUNT

75	32	Cast Iron	Ci3340	Plain Bearing	100	108	71	-20° to 280°	R3307	S3306*
100	32	High Temp Polymer	HT480	Du Oilless Bush	100	131	84	-20° to 280°	R4361	S4360*
100	36	Aluminium	AL472	Du Oilless Bush	100	131	84	-30° to 280°	R4381	S4380*
100	36	Aluminium	AL471	Bronze Bush	100	131	84	-30° to 400°	R4414	S4414*
100	30	Glass Filled Nylon	GF4420	Plain Bearing	100	131	84	-30° to 240°	R4403	S4402*
100	32	High Temp Polymer	HT480	Du Oilless Bush	100	131	84	-20° to 280°	R4361	S4360*



S4380

## ZINC DUROLITE SERIES - PLATE MOUNT

100	36	Aluminium	AL472	Du Oilless Bush	100	135	90	-30° to 280°	R4113	S4112*
100	32	High Temp Polymer	HT480	Ball Bearing	100	135	90	-30° to 280°	R4125	S4124*
100	32	High Temp Polymer	HT480	Du Oilless Bush	100	135	90	-20° to 280°	R4359	S4358*



S4358

## 300 SERIES - BOLT HOLE MOUNT

100	35	Glass Filled Nylon	GF412	Plain Bearing	200	130	90	-30° to 240°	-	S4228*
100	36	Aluminium	AL472	Du Oilless Bush	200	130	90	-30° to 280°	-	S4232*
100	38	Cast Iron	Ci421	Plain Bearing	200	130	90	-30° to 300°	-	S4234*



S4234

## 300 SERIES - PLATE MOUNT

100	35	Glass Filled Nylon	GF412	Plain Bearing	200	133	90	-30° to 240°	R4061	S4060*
100	36	Aluminium	AL474	Bronze Bush	200	133	90	-30° to 400°	R4067	S4066*
100	36	Aluminium	AL473	Du Oilless Bush	200	133	90	-30° to 280°	R4059	S4058*
100	38	Cast Iron	Ci421	Plain Bearing	200	133	90	-30° to 300°	R4051	S4050*
100	32	High Temp Polymer	HT481	Du Oilless Bush	200	133	90	-20° to 280°	R4355	S4354*
150	45	Cast Iron	Ci611	Plain Bearing	200	187	127	-30° to 300°	R6051	S6050*



R4067



S3306



S4232



S4352

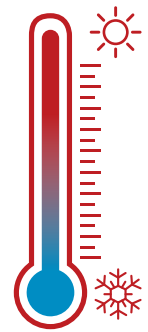

Castors to suit temps from -30° to +350°C with peaks up to 400°C.

Diameter (mm)	Width (mm)	Wheel Type	Wheel Code	Bearing Type	Load Capacity (kg)	Height (mm)	Swivel Radius (mm)	Temperature Range (C)	Rigid Code	Swivel Code
---------------	------------	------------	------------	--------------	--------------------	-------------	--------------------	-----------------------	------------	-------------

**HEAVY INDUSTRIAL SERIES - PLATE MOUNT**

100	36	Aluminium	AL474	Bronze Bush	200	142	84	-30° to 400°	R4467	S4466*
100	36	Aluminium	AL473	Du Oilless Bush	200	142	84	-30° to 280°	R4397	S4396*
100	35	Glass Filled Nylon	GF412	Plain Bearing	200	142	84	-30° to 240°	R4455	S4454*
100	38	Cast Iron	CI421	Plain Bearing	300	142	84	-30° to 300°	R4451	S4450*
100	32	High Temp Polymer	HT481	Du Oilless Bush	300	142	84	-20° to 280°	R4353	S4352*
150	45	Cast Iron	CI611	Plain Bearing	300	190	124	-30° to 300°	R6651	S6650*
150	50	Glass Filled Nylon	GF652	Plain Bearing	300	190	124	-30° to 240°	R6625	S6624



S6650



S4140

**STAINLESS EXCEL - PLATE MOUNT**

100	36	Aluminium	AL473	Du Oilless Bush	200	130	90	-30° to 280°	R4115	S4114*
100	35	Glass Filled Nylon	GF412	Du Oilless Bush	200	130	90	-30° to 240°	R4139	S4138*
100	36	Aluminium	AL474	Du Oilless Bush	200	130	90	-30° to 400°	R4141	S4140*
100	32	High Temp Polymer	HT481	Du Oilless Bush	200	130	90	-20° to 280°	R4127	S4126*



S4136

**STAINLESS EXCEL SERIES - BOLT HOLE MOUNT**

100	35	Glass Filled Nylon	GF412	Plain Bearing	200	130	90	-30° to 240°	-	S4136*
100	36	Aluminium	AL473	Du Oilless Bush	200	130	90	-30° to 280°	-	S4152*



S4356

**STAINLESS ELITE SERIES - PLATE MOUNT**

100	36	Aluminium	AL472	Du Oilless Bush	100	135	90	-30° to 280°	R4493	S4492*
100	32	High Temp Polymer	HT480	Oilless Bush	100	135	90	-20° to 280°	R4357	S4356*



Indicates castors suitable for high/low temperature applications.

\* Indicates castors not available with brake

Contact our team for assistance choosing the ideal castor for your application.

# STAINLESS ELITE BOLT CASTORS

SUITABLE FOR WET ENVIRONMENTS  
FULL STAINLESS CONSTRUCTION

These castors are manufactured from grade 304 stainless steel for health and hygiene applications, such as on medical or laboratory equipment. They are also seen fitted to food carts that are frequently moved through coolrooms and steamy kitchens. This range can be hose cleaned.

- Stainless steel double ball race swivel head
- Stainless steel thread guard on 100mm and 125mm models
- Plastic thread guard on 75mm models



Diameter (mm)	Width (mm)	Wheel Type	Wheel Code	Bearing Type	Load Capacity (KG)	Height (mm)	Swivel Radius	With Brake	Bolt Hole Size	Swivel Code
75	30	Poly Nylon	PU3345	SS Ball	80	105	70	105	12	S3384#
75	30	Nylon	NY3321	Plain	80	105	70	105	12	S3390#
75	32	Rebound Rubber	RR3367	SS Ball	80	105	70	105	12	S3391#
75	32	Elastic Rubber	ER3368	SS Ball	80	105	70	105	12	S3361#
100	27	Poly Nylon	PU4439	SS Ball	100	133	90	106	12	S4478
100	30	Nylon	NY4417	Plain	100	133	90	106	12	S4490
100	32	Rebound Rubber	RR4367	SS Ball	100	133	90	106	12	S4491#
100	32	Elastic Rubber	ER4368	SS Ball	100	133	90	106	12	S4461#
125	27	Poly Nylon	PU5539	SS Ball	100	159	102	106	12	S5578
125	30	Nylon	NY5517	Plain	100	159	102	106	12	S5590
125	27	Poly Nylon	PU5555	Ball	100	159	-	106	12	S5571B
125	32	Rebound Rubber	RR5367	SS Ball	100	159	102	106	12	S5591#
125	32	Elastic Rubber	ER5368	SS Ball	100	159	102	106	12	S5561#

## Brake Options

B = Brake  
D = Directional Lock

To order castors with Brake add B or D to end of swivel code e.g. S5578B

# indicates castors not available with directional lock.

## Castor Fitting Requirements

To fit this castor to a 20mm thick base requires a 50mm x 12mm set screw. Reduction bush 100RED12100BT available to allow fitting with 10mm set screw.

These castors have a 12mm bolt hole but can be reduced to suit an 8mm or 10mm bolt with a reduction bush (top hat).

12mm hole can be reduced to 8mm or 10mm

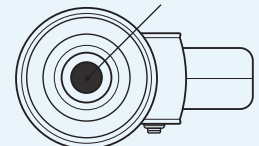

Reduction bushes available to suit 8mm fittings, code: 100RED12080BT  
to suit 10mm fittings, code: 100RED12100BT

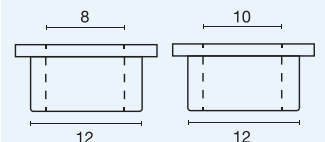

S4478B

S5578

## Nylon Expanding Pintles

Pintles listed below suit all Stainless Elite Bolt Castors

Pintle	Pintle Type	Pintle Code
	For 19mm ID Round Tube	IPN12-P1
	For 22mm ID Round Tube	IPN12-P2
	For 28.5mm ID Round Tube	IPN12-P3
	For 19mm ID Square Tube	IPN12-P4
	For 22mm ID Square Tube	IPN12-P5
	For 28.5mm ID Square Tube	IPN12-P6

SEE page 115 FOR SOLID AND THREADED PINTLE OPTIONS

# STAINLESS ELITE PLATE CASTORS

SUITABLE FOR WET ENVIRONMENTS  
FULL STAINLESS CONSTRUCTION

UP TO  
**100KG**  
CAPACITY



S4110B



S3104



S4488B

Diameter (mm)	Width (mm)	Wheel Type	Wheel Code	Bearing Type	Load Capacity (kg)	Height (mm)	Swivel Radius (mm)	With Brake (mm)	Rigid Code	Swivel Code
50	20	Poly Nylon	NA	SS Ball	30	69	50	77	R261	S260
50	20	Nylon	NA	Plain	30	69	50	77	R263	S262
75	30	Poly Nylon	PU3345	SS Ball	80	107	70	105	R3383	S3382#
75	30	Nylon	NY3321	Plain	80	107	70	105	R3389	S3388#
75	32	Rebound Rubber	RR3367	SS Ball	80	107	70	105	R3387	S3386#
75	32	Elastic Rubber	ER3368	SS Ball	80	107	70	105	R3315	S3315#
100	27	Poly Nylon	PU4439	SS Ball	100	135	90	106	R4477	S4476
100	30	Nylon	NY4417	Plain	100	135	90	106	R4489	S4488
100	32	Rebound Rubber	RR4367	SS Ball	100	135	90	106	R4429	S4428#
100	32	Elastic Rubber	ER4368	SS Ball	100	135	90	106	R4416	S4415#
100	36	Aluminium	AL472	Oiless Du bush	100	135	90	-	R4493	S4492#
125	27	Poly Nylon	PU5539	SS Ball	100	161	102	106	R5577	S5576
125	30	Nylon	NY5517	Plain	100	161	102	106	R5589	S5588
125	32	Rebound Rubber	RR4367	SS Ball	100	135	90	106	R4429	S4428#
125	32	Elastic Rubber	ER5368	SS Ball	100	161	102	106	R5516	S5515#

## Brake Options

B = Brake  
D = Directional Lock

To order castors with Brake or Directional Lock add B or D to end of swivel code e.g. S4476B

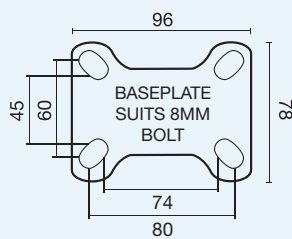

Baseplate for Rigid Castors

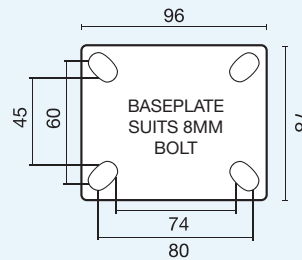

Baseplate for Swivel Castors

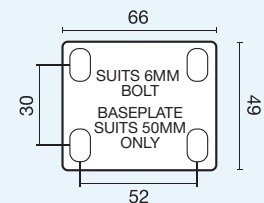

# indicates castors not available with directional lock.



# STAINLESS EXCEL BOLT CASTORS

SUITABLE FOR WET ENVIRONMENTS  
FULL STAINLESS CONSTRUCTION

This range has a heavy-duty pressed stainless steel frame and full stainless componentry. They are the ideal choice for use in wet areas, frequent wash-down applications and in food and health industries. They can be fitted to equipment and trolleys with multiple options such as pre-fitted threaded inserts, solid drilled metal pintles, expanding pintles or a single bolt or plate fitting.

- Large variety of wheel types
- Ideal for wash-down applications



S4146B

Diameter (mm)	Width (mm)	Wheel Type	Wheel Code	Bearing Type	Load Capacity (kg)	Height (mm)	Swivel Radius (mm)	With Brake (mm)	Bolt Hole Size (mm)	Swivel Code
100	35	Reb Poly	RP4072	SS Roller	200	130	90	125	12	S4148
100	35	High Temp Polymer	HT412	Plain	200	130	90	-	12	S4136*
100	35	Nylon	NY401	Plain	200	130	90	125	12	S4146
100	36	Aluminium	AL473	Oiless Du Bush	200	130	90	-	12	S4152*
125	35	Reb Poly	RP5072	SS Roller	200	157	112	125	12	S5148
125	35	Nylon	NY501	Plain	200	157	112	125	12	S5146
150	50	Reb Poly	RP6072	SS Roller	300	183	127	127	12	S6148
150	50	Nylon	NY652	Plain	300	183	127	127	12	S6146
150	50	Nylon	NY655	SS Roller	300	183	127	150	12	S6150

## Brake Options

B = Brake

To order castors with Brake add B to end of swivel code e.g. S6146B

## Castor Fitting Requirements

To fit to 20mm thick base requires a 50mm x 12mm stainless steel set screw.

indicates castors suitable for high/low temperature applications.

These castors have a 12mm bolt hole but can be reduced to suit an 10mm bolt with a reduction bush (top hat).

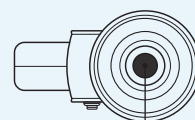

12mm hole can be reduced to 8mm or 10mm

Reduction bushes available to suit 10mm fittings, code: 100RED12100BT

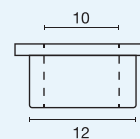

## Nylon Expanding Pintles

Pintles listed below suit all Stainless Excel Bolt Castors

Pintle	Pintle Type	Pintle Code
	For 19mm ID Round Tube	IPN12-P1
	For 22mm ID Round Tube	IPN12-P2
	For 28.5mm ID Round Tube	IPN12-P3
	For 19mm ID Square Tube	IPN12-P4
	For 22mm ID Square Tube	IPN12-P5
	For 28.5mm ID Square Tube	IPN12-P6



S4148B

S6146

SEE page 115 FOR SOLID AND THREADED PINTLE OPTIONS

# STAINLESS EXCEL PLATE CASTORS

SUITABLE FOR WET ENVIRONMENTS  
FULL STAINLESS CONSTRUCTION

UP TO  
**400KG**  
CAPACITY



S4144B



S4114



S5142B

Diameter (mm)	Width (mm)	Wheel Type	Wheel Code	Bearing Type	Load Capacity (kg)	Height (mm)	Swivel Radius (mm)	With Brake (mm)	Rigid Code	Swivel Code
100	35	Reb Poly	RP4072	SS Roller	200	133	92	115	<b>R4145</b>	<b>S4144</b>
100	32	High Temp Polymer	HT479	Ball	200	133	92	-	<b>R4127</b>	<b>S4126*</b>
100	35	Nylon	NY401	Plain	200	133	92	115	<b>R4143</b>	<b>S4142</b>
100	36	Aluminium	AL473	Oiless Du Bush	200	133	92	-	<b>R4115</b>	<b>S4114*</b>
100	36	Aluminium	AL474	Oiless Du Bush	200	133	92	-	<b>R4141</b>	<b>S4140*</b>
100	35	High Temp Polymer	HT412	Plain	200	133	92	115	<b>R4139</b>	<b>S4138*</b>
125	35	Reb Poly	RP5072	SS Roller	200	158	158	120	<b>R5145</b>	<b>S5144</b>
125	35	Nylon	NY501	Plain	200	158	158	120	<b>R5143</b>	<b>S5142</b>
150	50	Reb Poly	RP6072	SS Roller	300	187	127	150	<b>R6145</b>	<b>S6144</b>
150	50	Nylon	NY652	Plain	300	187	127	150	<b>R6143</b>	<b>S6142</b>
150	50	Nylon	NY655	SS Roller	300	187	127	150	<b>R6141</b>	<b>S6140</b>
200	50	Reb Poly	RP8072	SS Roller	300	237	156	150	<b>R8145</b>	<b>S8144</b>
200	45	Nylon	NY800	Plain	380	237	156	150	<b>R8143</b>	<b>S8142</b>
200	50	Nylon	NY802	SS Roller	380	237	156	150	<b>R8141</b>	<b>S8140</b>
200	43	High Temp Polymer	HT800	Plain	380	237	156	150	<b>R8149</b>	<b>S8148</b>

## Brake Options

B = Brake  
To order castors with a Brake add B to end of swivel code e.g. S5144B

indicates castors suitable for high/low temperature applications.

\* indicates castors not available with brake

Part numbers in red indicate an M2 baseplate. All other part numbers in this series have an M3 baseplate.

### Standard Baseplate Dimensions & Drilling Patterns for Stainless Steel Excel Castors

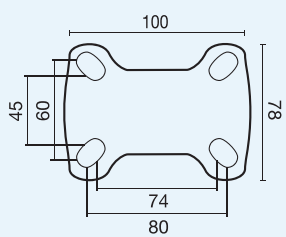

Baseplate for 100-125mm Rigid Castors

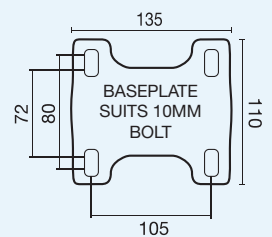

Baseplate for 150-200mm Rigid Castors

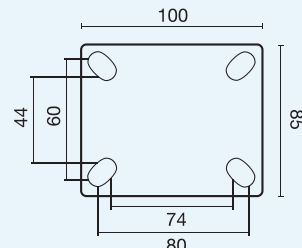

Baseplate for 100-125mm Swivel Castors

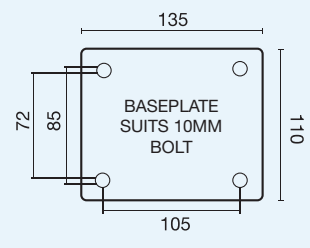

Baseplate for 150-200mm Swivel Castors

# STAINLESS HEAVY INDUSTRIAL SERIES CASTORS

SUITABLE FOR WET ENVIRONMENTS  
FULL STAINLESS CONSTRUCTION









These premium heavy-duty castors are suitable for heavier loads of up to 400kg per castor.

They are suitable for wash-down applications due to their polished grade 304 stainless steel construction. Stainless steel roller bearing options are available.

- Stainless steel grease nipple for added lubrication
- Stainless steel upper & lower ball bearings for added corrosion resistance
- Nylon head seal for added protection from water and other outside factors



S6382SLB

 Diameter (mm)	 Width (mm)	 Wheel Type	 Wheel Code	 Bearing Type	 Load Capacity	 Height (mm)	 Swivel Radius	 Rigid Code	 Swivel Code
100	50	Nylon	NY404	SS Roller	250	140	84	R4377	S4376
100	50	Rebound Poly	RP4073	SS Roller	250	140	84	R4383	S4382
125	50	Nylon	NY504	SS Roller	250	165	100	R5381	S5380
125	50	Rebound Poly	RP5073	SS Roller	250	165	100	R5383	S5382
150	50	Nylon	NY655	SS Roller	400	190	124	R6381	S6380
150	50	Nylon	NY652	Plain	400	190	124	R6385	S6384
150	50	Rebound Poly	RP6072	SS Roller	300	190	124	R6383	S6382
200	50	Nylon	NY800	SS Roller	400	240	156	R8381	S8380
200	50	Nylon	NY802	Plain	400	240	156	R8385	S8384
200	50	Rebound Poly	RP8072	SS Roller	300	240	156	R8383	S8382

## Brake Options

SLB = Swivel Lock & Brake  
D = Directional Lock

To order castors with Swivel Lock & Brake or Directional Lock add SLB or D to end of swivel code e.g. S6382SLB

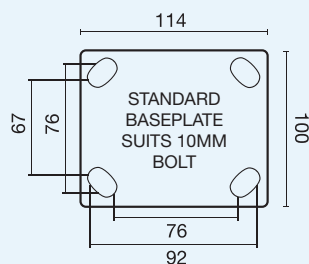

Baseplate Dimensions for Heavy Industrial Castors













S6380

# MEDI TWIN SERIES

## MEDICAL CASTORS

This series has been designed for medical applications such as on medical carts and monitor trolleys. Twin polyurethane wheels are non-marking and provide a smooth ride. These castors are an attractive choice for all medical and healthcare environments, and are available with brakes.

- Non-marking polyurethane wheels
- Available with brakes

 Diameter (mm)	 Width (mm)	 Height (mm)	 Wheel Type	 Thread Size	 Bearing Type	 Load Capacity (kg)	 Swivel Radius	 With Brake	 Swivel Code
75	2 x 12	94	Polyurethane	M12 x 20	Plain	60	60	72	S3367
100	2 x 12	127	Polyurethane	M12 x 25	Plain	90	80	92	S4310
100	2 x 12	147	Polyurethane	M12 x 40	Plain	90	-	92	S4300B
125	2 x 12	149	Polyurethane	M12 x 25	Plain	100	100	112	S5313

### Brake Options

B = Brake

To order castors with Brake add B to end of swivel code e.g. S4310B



S3367



S3367B



S4310



S4310B

# THERMOPLASTIC RUBBER MEDICAL CASTORS

These castors are ideal for light to medium duty applications, such as on shower and commode chairs, food service trolleys and racking, utility trolleys and hospital equipment.

Thermoplastic wheels are quiet running, non-marking and offer a low rolling resistance. An enclosed plastic housing design reduces the amount of bacteria that sticks to the castor and components.

- Suitable for wash-down applications
- Attractive grey finish



### ENCLOSED PLASTIC DESIGN

Less exposed metal components, reducing the amount of bacteria that sticks to the castor and components.

### ATTRACTIVE GREY NYLON FRAME

Suitable for washdown applications.

### NON-MARKING WHEELS

Protect floors and surfaces.

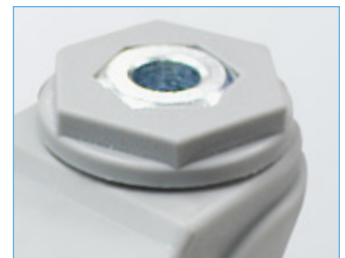

Diameter (mm)	Width (mm)	Height (mm)	Wheel Type	Bolt Hole	Bearing Type	Load Capacity (kg)	Swivel Radius (mm)	With Brake (mm)	Swivel Code
75	32	112	Thermoplastic Rubber	M10	Ball Bearing	80	75	95	S3392
100	32	140	Thermoplastic Rubber	M12	Ball Bearing	100	85	105	S4386
125	32	168	Thermoplastic Rubber	M12	Ball Bearing	100	105	110	S5386

## Brake Options

B = Brake

To order castors with Brake or directional lock add B to end of swivel code e.g. S3392B

# CENTRAL LOCKING

## MEDICAL CASTORS

This range are ideal for use on hospital beds and equipment. They feature a central locking system, offering free swivel, total lock or directional lock administered via the castor stem. These castors are smooth running, offer positive brake performance, quiet motion and an attractive chrome finish.

- Grey rubber wheels
- Central locking stem system

Diameter (mm)	Width (mm)	Wheel Type	Bearing Type	Load Capacity (kg)	Height (mm)	Stem Diameter (mm)	Swivel Radius	Swivel Code
100	32	Grey Rubber	Ball	100	142	28	80	S4293
125	32	Grey Rubber	Ball	100	164	28	102	S5293
150	32	Grey Rubber	Ball	120	192	28	125	S6293
200	32	Grey Rubber	Ball	120	240	28	157	S8293

### Brake Options

- B = Brake
- D = Directional Lock

To order castors with Brake or directional lock add B or D to end of swivel code e.g. S5296B

The markings at the top of the castor stem denote the brake type of that castor

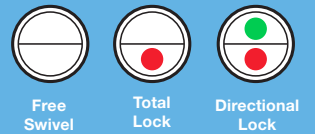

### Central Locking Medical Castors Stem Measurements

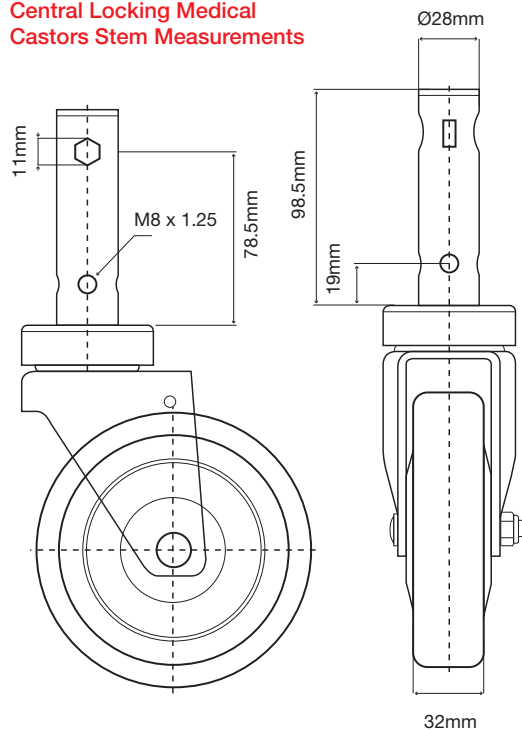

S5293



S5293B

# ABS CENTRAL LOCKING TWIN WHEEL MEDICAL CASTORS

These castors are suitable for patient beds requiring one-point locking and minimal maintenance. The ABS cover and precision ball bearing swivel head assists in swivelling the castor, making beds and stretchers easy to position at any time. The polyurethane wheels are non-marking and quiet running.

- Twin polyurethane wheels
- Positive brake performance



Diameter (mm)	Width (mm)	Wheel Type	Bearing Type	Load Capacity (KG)	Height (mm)	Stem Diameter (mm)	Swivel Radius	Swivel Code
125	15 x 2	Polyurethane	Ball	120	165	28	102	<b>S5296</b>
150	18 x 2	Polyurethane	Ball	150	192	28	125	<b>S6296</b>
150	18 x 2	Polyurethane	Ball	150	192	32	125	<b>S6298</b>

## Brake Options

- B = Brake
- D = Directional Lock

To order castors with Brake or directional lock add B or D to end of swivel code e.g. S5296B

The markings at the top of the castor stem denote the brake type of that castor:

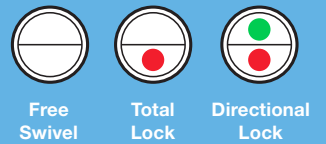

## Fine Adjustment for Wheel Lock

Unlock and remove cap to access the adjustment screw for fine tuning the brake tightness.

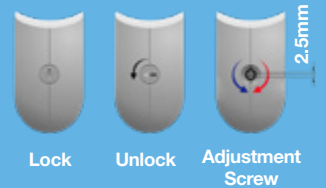

ABS Twin Wheel castors with 28mm stem diameter

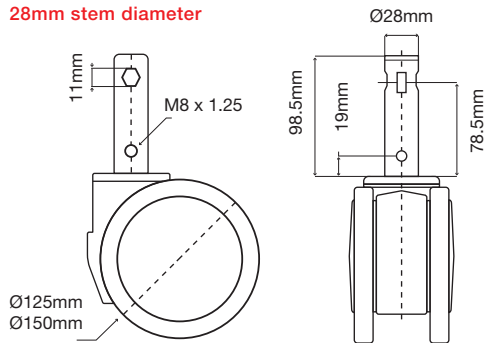



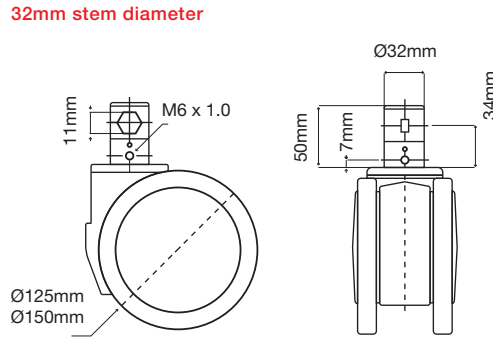



ABS Twin Wheel castors with 32mm stem diameter



# ABS CENTRAL LOCKING SINGLE WHEEL MEDICAL CASTORS

Like the Twin Wheel range, this range is suitable for patient beds requiring one-point locking and minimal maintenance. The ABS cover and precision ball bearing swivel head assists in swivelling the castor, making beds and stretchers easy to position at any time. The polyurethane wheels are non-marking and quiet running.

- Single polyurethane wheels
- Positive brake performance

 Diameter (mm)	 Width (mm)	 Wheel Type	 Bearing Type	 Load Capacity (kg)	 Height (mm)	 Stem Diameter (mm)	 Swivel Radius	 Swivel Code
125	32	Inst Rubber	Ball	100	165	28	102	<b>S5295</b>
150	32	Inst Rubber	Ball	120	192	28	125	<b>S6295</b>
150	32	Inst Rubber	Ball	120	192	32	125	<b>S6297</b>
200	32	Inst Rubber	Ball	120	240	28	157	<b>S8295</b>

## Brake Options

B = Brake  
D = Directional Lock

To order castors with Brake or directional lock add B or D to end of swivel code e.g. S5296B

The markings at the top of the castor stem denote the brake type of that castor:

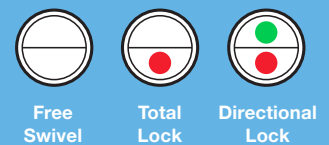

### ABS Central Locking 28mm Stem

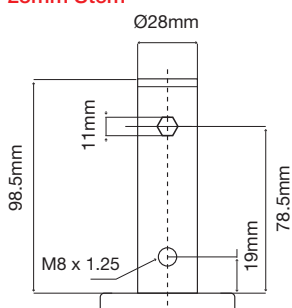

### ABS Central Locking 32mm Stem

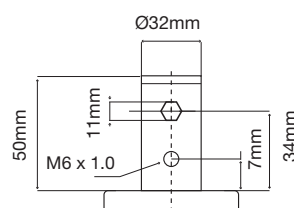

## Fine Adjustment for Wheel Lock

Unlock and remove cap to access the adjustment screw for fine tuning the brake tightness.

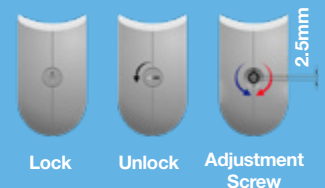









# REFRIGERATION CASTORS

This range has been designed specifically for use on catering refrigeration units, merchandisers, food services and preparation counters. They are designed to be a compatible replacement product for most commercial equipment and major brands.

- Nylon wheels
- Plate or bolt hole mounting options

**UP TO  
80KG  
CAPACITY**

 Diameter (mm)	 Width (mm)	 Wheel Type	 Bearing Type	 Load Capacity (kg)	 Height (mm)	 Swivel Radius (mm)	 With Brake (mm)	 Thread Size	 Swivel Code
75	30	Nylon	Plain	80	100	62	65	3/4" BSW	<b>S3298</b>
75	30	Nylon	Plain	80	107	71	105	3/4" BSW	<b>S3300</b>
75	30	Nylon	Plain	80	90	62	65	Plate	<b>S3296</b>



S3296B



S3300



S3298B

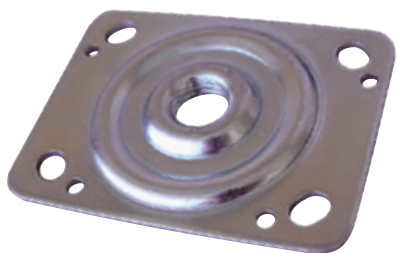

REFPLT10983  
Optional baseplate to suit New Zealand style SKOPE brand equipment

## Brake Options

B = Brake

To order castors with Brake add B to end of swivel code e.g. S3296B

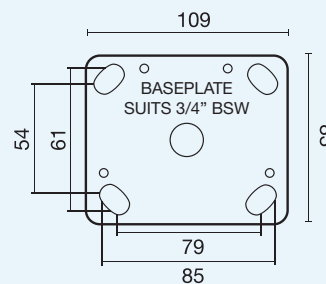

**Baseplate Dimensions for Refrigeration Castors**

# STAINLESS STEEL CATERING LEGS

Catering legs are suitable for use on catering equipment such as display fridges, preparation tables and bain maries. They are made from grade 304 stainless steel and are interchangeable with leading manufacturers. The use of catering legs allows for easy access underneath equipment to ensure a clean and hygienic environment. They feature an adjusting design, allowing for the quick levelling of your bench or fridge.

- Grade 304 stainless steel
- Adjustable for quick levelling



CATERLEG100

CATERLEG150

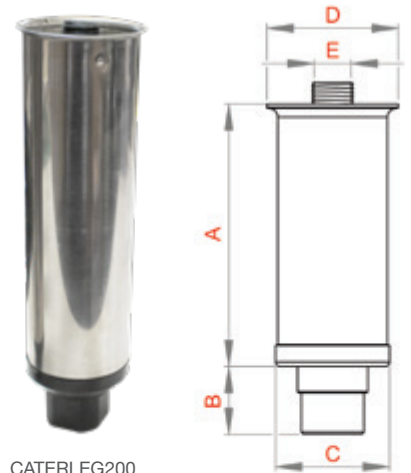

CATERLEG200

Height mm	Adjustment Height (mm)	Tube Diameter (mm)	Flange (mm)	Thread	Load Capacity (kg)	Product Code
130	130-147	50	60	3/4" BSW	400	REFADJLEG146*
75	100-125	51	62	3/4" BSW	400	CATERLEG100
100	125-150	51	62	3/4" BSW	400	CATERLEG125
115	115-150	51	62	3/4" BSW	400	CATERLEG150
175	200-225	51	62	3/4" BSW	400	CATERLEG200
225	250-275	51	62	3/4" BSW	400	CATERLEG250

\*REFADJLEG146 has a thread that extends 9mm above the flange. All of the other models sit flat once a baseplate is threaded on.

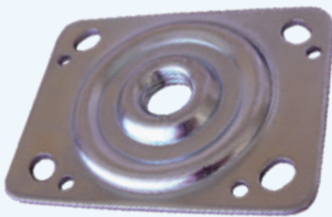

REFPLT10983

Compatible with New Zealand style SKOPE brand display fridge units and bain maries. Plate is in zinc plated mild steel.

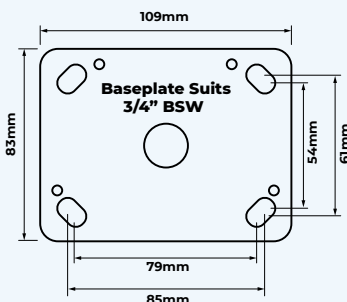

CATERPLATEZP

Compatible with major manufacturer display fridges, preparation benches, bain maries, display cabinets etc. This baseplate is made from zinc plated mild steel.

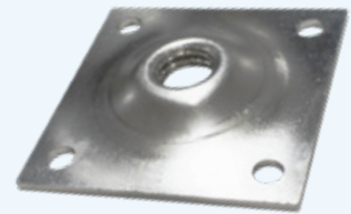
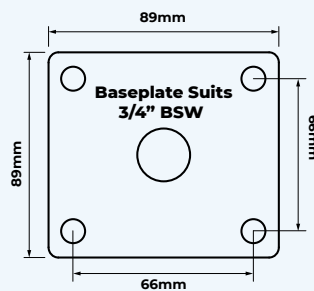

CATERPLATESS

Compatible with major manufacturer display fridges, preparation benches, bain maries, display cabinets etc. This baseplate is made from grade 304 stainless steel.

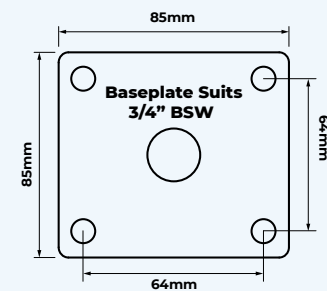

# LOW PROFILE CASTORS

These castors are ideal for maintaining a low overall height and centre of gravity without compromising on a high load capacity. The hard-wearing nylon wheels offer low rolling resistance, minimal maintenance and maximum strength. They are suitable for use on manufacturing equipment, electrical cabinets, office equipment and more.

- Low overall height with high load capacity
- Swivel plate or bolt hole mounting options



S3006B



## LOW PROFILE BOLT CASTOR

Diameter (mm)	Width (mm)	Wheel Type	Bearing Type	Load Capacity (kg)	Height (mm)	Swivel Radius (mm)	With Brake (mm)	Thread Size	Swivel Code
50	38	Nylon	Plain	300	79	40	55	M16 x 25	S2005
75	50	Nylon	Plain	600	105	55	105	M16 x 25	S3005



S3005

## LOW PROFILE PLATE CASTOR

Diameter (mm)	Width (mm)	Wheel Type	Bearing Type	Load Capacity (kg)	Height (mm)	Swivel Radius (mm)	With Brake (mm)	Rigid Code	Swivel Code
50	38	Nylon	Plain	300	79	40	55	R2007	S2006
75	50	Nylon	Plain	600	105	55	105	R3007	S3006



S2006

## Brake Options

B = Brake

To order castors with Brake add B to end of swivel code e.g. S2006B

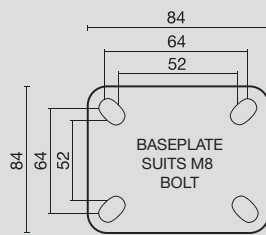

Baseplate for 50mm Low Profile Castors

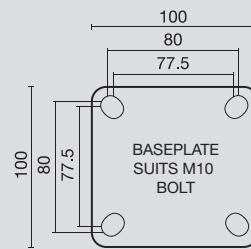

Baseplate for 75mm Low Profile Castors

# LEVELLING STAND CASTOR

This castor is ideal for moving, levelling and immobilising equipment.

It allows for leveling adjustment of up to 10mm over the total height of the castor, offering a multitude of uses.



S55LEVELR

Diameter (mm)	Wheel Width (mm)	Wheel Type	Bearing Type	Load Capacity (kg)	Lowered Height (mm)	Max Adjusted Height (mm)	Part Number
50	24	Nylon	Plain	200	84	94	S55LEVELR

# ADJUSTABLE HEIGHT CASTOR

This castor is adjustable from 150mm to 160mm in height.

It is ideal for levelling equipment on uneven floors, or adjusting to a height the best suits your working needs. The levelling action is activated by twisting the top of the castor. This castor is most commonly used on kitchen equipment and is suitable for all kinds of commercial kitchen and industrial applications.



S75

Diameter (mm)	Wheel Width (mm)	Wheel Type	Bearing Type	Load Capacity (kg)	Lowered Height (mm)	Max Adjusted Height (mm)	Part Number
75	33	Nylon	Plain	80	150	170	S75

## Brake Options

B = Brake

To order the castor with Brake add B to end of swivel code e.g. S75B

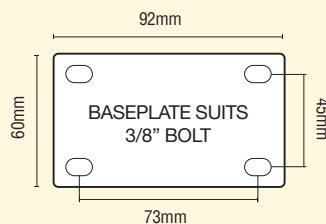

Baseplate for Adjustable Height Castor

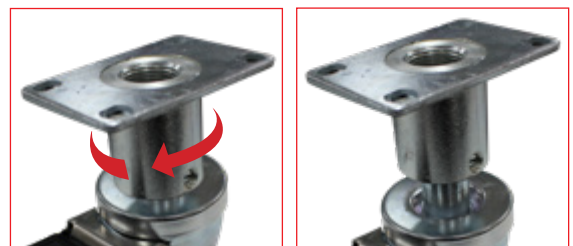

Using a simple twist motion the castor can be adjusted to a new height, where it can then be locked in place.

# SCAFFOLD CASTORS

These scaffold castors are compatible with Kwik Stage Steel Scaffolding and mobile Aluminium Scaffolding/ Platform products. They are tested and approved to AS1576.2 2009 standards.

They are designed to accommodate a variety of scaffold tubing including mild steel or aluminium with an outer diameter of 48.3mm. Solid round tubing is also suitable with an outer diameter not exceeding 50mm.

The adjustable scaffold castor is designed to accommodate a variety of scaffold tube including mild steel or aluminium with an outer diameter of 48.3mm and internal diameter of 39.46mm.

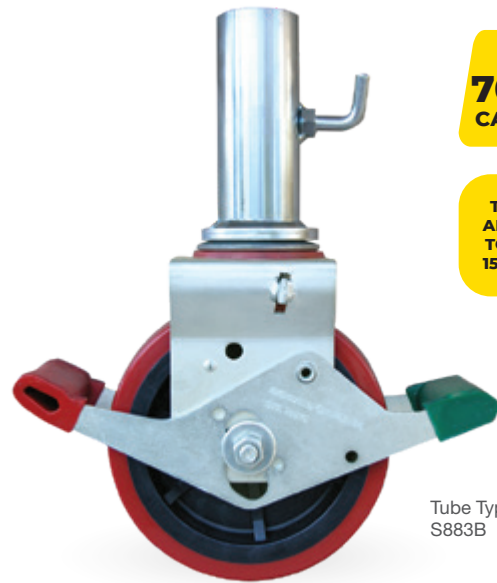

Tube Type  
S883B

UP TO  
**700KG**  
CAPACITY

TESTED &  
APPROVED  
TO AS/NZS  
1576.2:2009

## TUBE TYPE SCAFFOLD CASTOR TO SUIT 48MM OD TUBE

Diameter (mm)	Width (mm)	Wheel Type	Wheel Code	Bearing Type	Load Capacity (kg)	Swivel Code
200	50	Poly Nylon	PU8079	Roller	700	S883B



Adjustable  
Thread  
S879B

UP TO  
**700KG**  
CAPACITY

TESTED &  
APPROVED  
TO AS/NZS  
1576.2:2009

## ADJUSTABLE THREAD TYPE SCAFFOLD CASTOR

Diameter (mm)	Width (mm)	Wheel Type	Wheel Code	Bearing Type	Height Adjustment (mm)	Load Capacity (kg)	Swivel Code
200	50	Poly Nylon	PU8079	Roller	310-450	700	S879B

Additional socket and pin sizes are available. Contact us to find out more.

# TUBE TYPE PLATFORM CASTORS

This castor suits round solid or tubular tube with a maximum outer diameter of 38mm. This castor is not suitable for use on scaffolding.

Diameter (mm)	Width (mm)	Wheel Type	Load Capacity (kg)	Swivel Code
125	35	Rebound Rubber	150	S551B



S551B



# PINTLE TYPE PLATFORM CASTORS

This castor features a high capacity poly tyred nylon centred wheel design with a swivel lock & brake frame and a 27mm pintle stem. This castor is not suitable for use on scaffolding.

Diameter (mm)	Width (mm)	Wheel Type	Wheel Code	Load Capacity (kg)	Swivel Code
150	50	Polyurethane	PU6071	400	S6654B



S6654B



## There Are 3 Common Scaffold Castor Fixing Methods:

### 1: Hollow Nut:

Suitable for Kwik stage steel scaffold leg: 48.3mm OD x 4.0mm wall thickness = 40.3NB, Aluminium Scaffold leg 48.4mm OD x 4.47mm wall thickness = 39.46 nominal bore

Adjustable scaffold castor are designed to accommodate a variety of scaffold tube including mild steel or aluminium with an maximum outer diameter of 48.3mm diameter and internal dimension 38.5mm.

### 2: Internal Tube:

Suitable for Kwik stage steel scaffold leg: 48.3mm OD x 4.0mm wall thickness = 40.3NB, Aluminium Scaffold leg 48.4mm OD x 4.47mm wall thickness = 39.46 nominal bore

Tube scaffold castor are designed to accommodate a variety of scaffold tubing including mild steel or aluminium with an outer diameter not exceeding 48.3mm.

### 3: Solid Stem:

Kwik stage steel scaffold leg: 48.3mm OD x 4.0mm wall thickness = 40.3NB  
Aluminium Scaffold leg 48.4mm OD x 4.47mm wall thickness = 39.46NB

Solid round stem castors are also suitable with an outer diameter not exceeding 49mm. Solid stem castor fixing requires the stem to be secured in place to ensure it cannot fallout when raised or placed on uneven surfaces.

# SPRING LOADED GATE CASTORS



This range of spring-loaded gate castors are designed to make opening and closing of residential gates easier. The spring design provides shock absorption features specifically for use on uneven surfaces. The gate mount is integrated into the frame of the castor for ease of fixing to any gate system.

- Rebound rubber or nylon wheels
- Shock absorbing spring design
- For residential gates

Diameter (mm)	Width (mm)	Wheel Type	Wheel Code	Bearing Type	Load Capacity (kg)	Height (mm)	Swivel Code
75	30	Reb Rubber	RR3348	Ball	20	259	S3022
75	30	Nylon	NY3321	Plain	20	259	S3024
75	25	Nylon	NY3324	Plain	25	100	S3712SPR
100	30	Reb Rubber	RR4473	Ball	20	285	S4022
100	30	Nylon	NY4417	Plain	20	285	S4024
125	30	Reb Rubber	RR5573	Ball	20	311	S5022
125	30	Nylon	NY5517	Plain	20	311	S5024



S3022

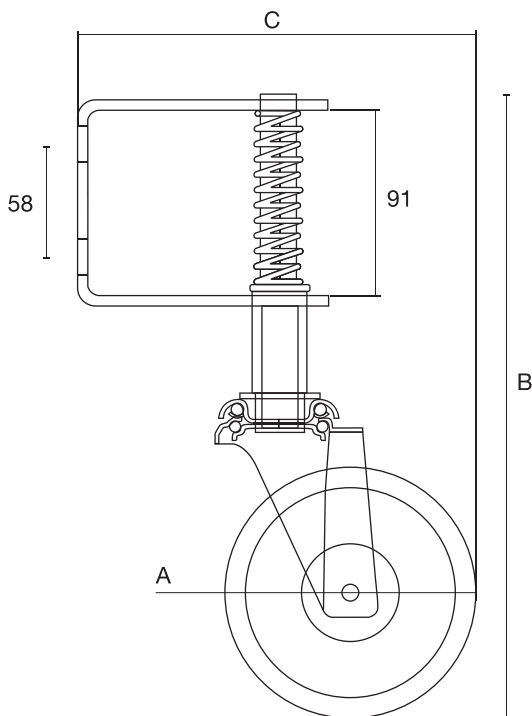

S3712SPR

# JOCKEY WHEELS

Jockey wheels are suitable for use on caravans, campers, boat trailers and other trailers used for transporting goods for leisure or business. They are available in swing-up and clamp style models.



### Please Note

When moving equipment, the best performance is achieved with the jockey wheel being at its lowest position. Moving equipment with the jockey wheel in a high position is not safe or advised. All load capacities are based on smooth concrete or asphalt surfaces.

### Example of heavy duty plate assembly

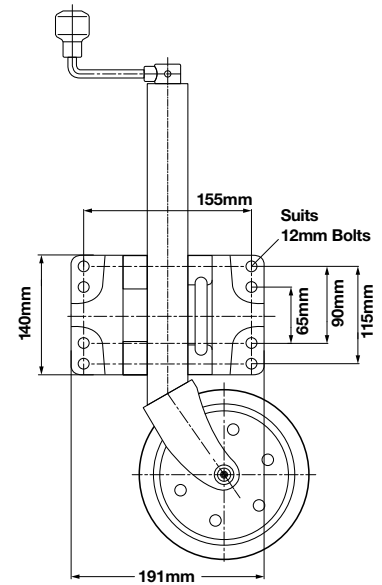

### JOCKEY WHEELS

Diameter (mm)	Wheel Width (mm)	Wheel Type	Lowered Height (mm)	Raised Height (mm)	Static Load Capacity (kg)	Product Code
150	45	Black Rubber	540	850	350	S6026
150	45	Black Rubber	540	850	350	S6066
200	55	Rubber Tyred	600	890	400	S8026
200	85	Rubber Tyred	600	890	400	S8037
250	85	Rubber Tyred	650	910	400	S1073

### JOCKEY STANDS

Lowered Height (mm)	Raised Height (mm)	Static Load Capacity (kg)	Part Number
420	640	400	TJS001
440	690	400	TJS003

### JOCKEY WHEEL SPARE PARTS

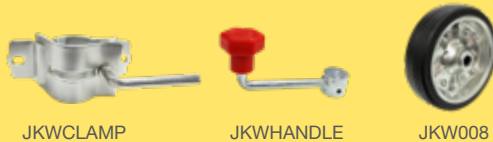

Description	Part Number
Clamp to suit S6026 jockey wheel, suits 12mm bolt, 145mm hole centres	<b>JKWCLAMP</b>
Handle to suit jockey wheels, 145mm overall width, suits 12mm shaft	<b>JKWHANDLE</b>
150mm (6") black rubber wheel to suit S6026 & S6066 jockey wheels	<b>JKW006</b>
200mm (8") rubber tyred wheel to suit S8026 jockey wheels	<b>JKW008</b>
250mm (10") rubber tyred wheel to suit S1073 jockey wheels	<b>JKW010</b>

### U-BOLTS TO SUIT

All U-Bolts are made from zinc plated steel

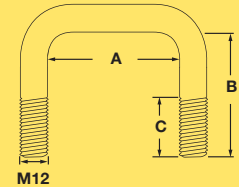

Suits Draw Bar	A (mm)	B (mm)	C (mm)	Part Number
50 x 50mm	53	78	40	<b>UBOLT50X50</b>
75 x 50mm	77	78	40	<b>UBOLT75X50</b>
75 x 75mm	77	103	40	<b>UBOLT75X75</b>
100 x 50mm	103	40	103	<b>UBOLT100X50</b>

# GLASS HANDLING BALL TRANSFER CASTORS

These castors have been designed for the smooth and efficient transfer of glass and other flat sheet materials with minimal impact or damage.

They are available in polyurethane or rubber varieties. Rubber ball transfers offer better grip, while polyurethane ball transfers offer a more wear-resistant option.



**S039**  
38mm Polyurethane Ball Castor

- 15kg Capacity
- 14mm Thread

**S051**  
50mm Polyurethane Ball Castor

- 20kg Capacity
- 14mm Thread

**S038**  
38mm Rubber Ball Castor

- 15kg Capacity
- 14mm Thread

**S050**  
50mm Rubber Ball Castor

- 20kg Capacity
- 14mm Thread



We can custom design and manufacture glass ball transfer tables. Contact us to find out more.

# BASEPLATE MOUNTS & STILLAGE FEET

Richmond has a range of mounting plates to suit most castors. These are ideal for welding to your base frame.

Stillage feet are primarily designed for stillages and crates that need to be stackable. They have a heavy duty press steel construction, a square base for stability and are unpainted, ready to weld.

## How to use the baseplate mounts:

- Weld the baseplate onto your table leg or bench leg etc.
- Using bolts, attach a castor with matching top plate to the baseplate.

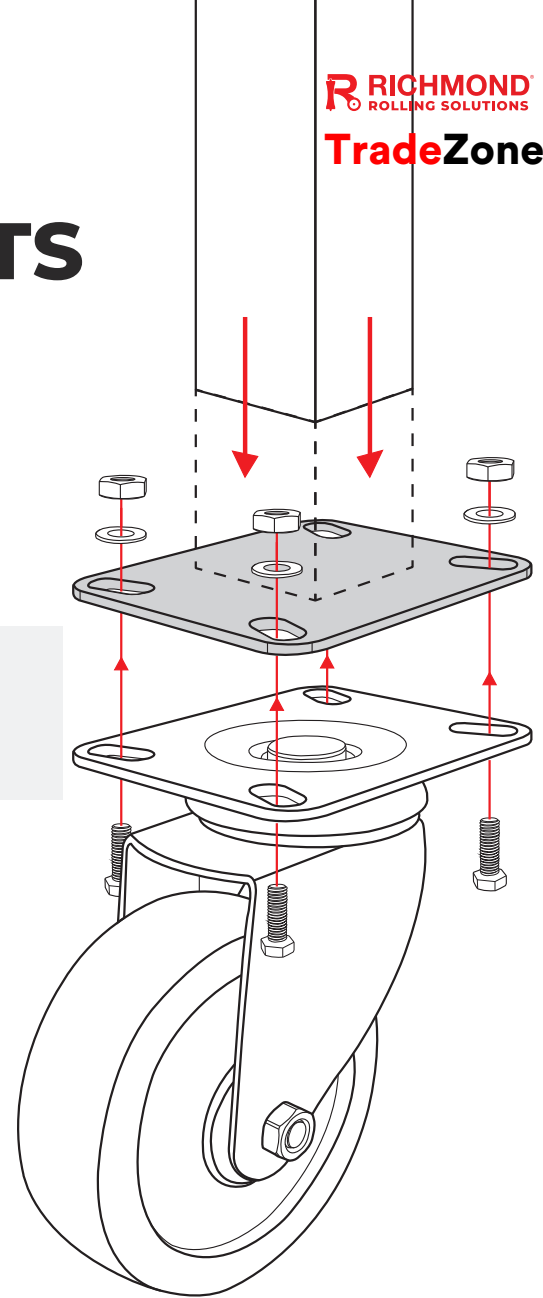

### BPR01

**Base plate size:** 96 x 70mm  
**Hole centres:** 75 x 45mm  
**Suits bolt size:** 8mm  
**Series:** Light Industrial



### BPR02

**Base plate size:** 96 x 78mm  
**Hole centres:** 80 x 60mm  
**Suits bolt size:** 8mm  
**Series:** Zinc Durolite + 300

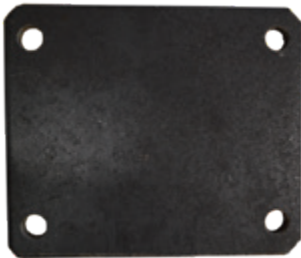

### BPR05

**Base plate size:** 130 x 110mm  
**Hole centres:** 105 x 80mm  
**Suits bolt size:** 3/8"  
**Series:** Heavy Industrial M3



### BPR04

**Base plate size:** 114 x 100mm  
**Hole centres:** 76 x 67/92 x 76mm  
**Suits bolt size:** 3/8"  
**Series:** Heavy Industrial



### BPR07

**Base plate size:** 177 x 100mm  
**Hole centres:** 152 x 76mm  
**Suits bolt size:** 10mm  
**Series:** 500 + 1000



### STILLFEET2

**Base plate size:** 130 x 130mm  
**Height:** 50mm  
**Top Section:** 65 x 65mm  
**Mounting Hole Size:** 10mm  
**Base Thickness:** 3mm

# WHEELS & ROLLERS

Wheels are the heart and soul of who we are. We have thousands of wheel choices in our standard range, and if we don't have what you're looking for, we can design and manufacture it for you. Our wheels are available with load capacities from 10kg up to 10T, with a large variety of wheel types.

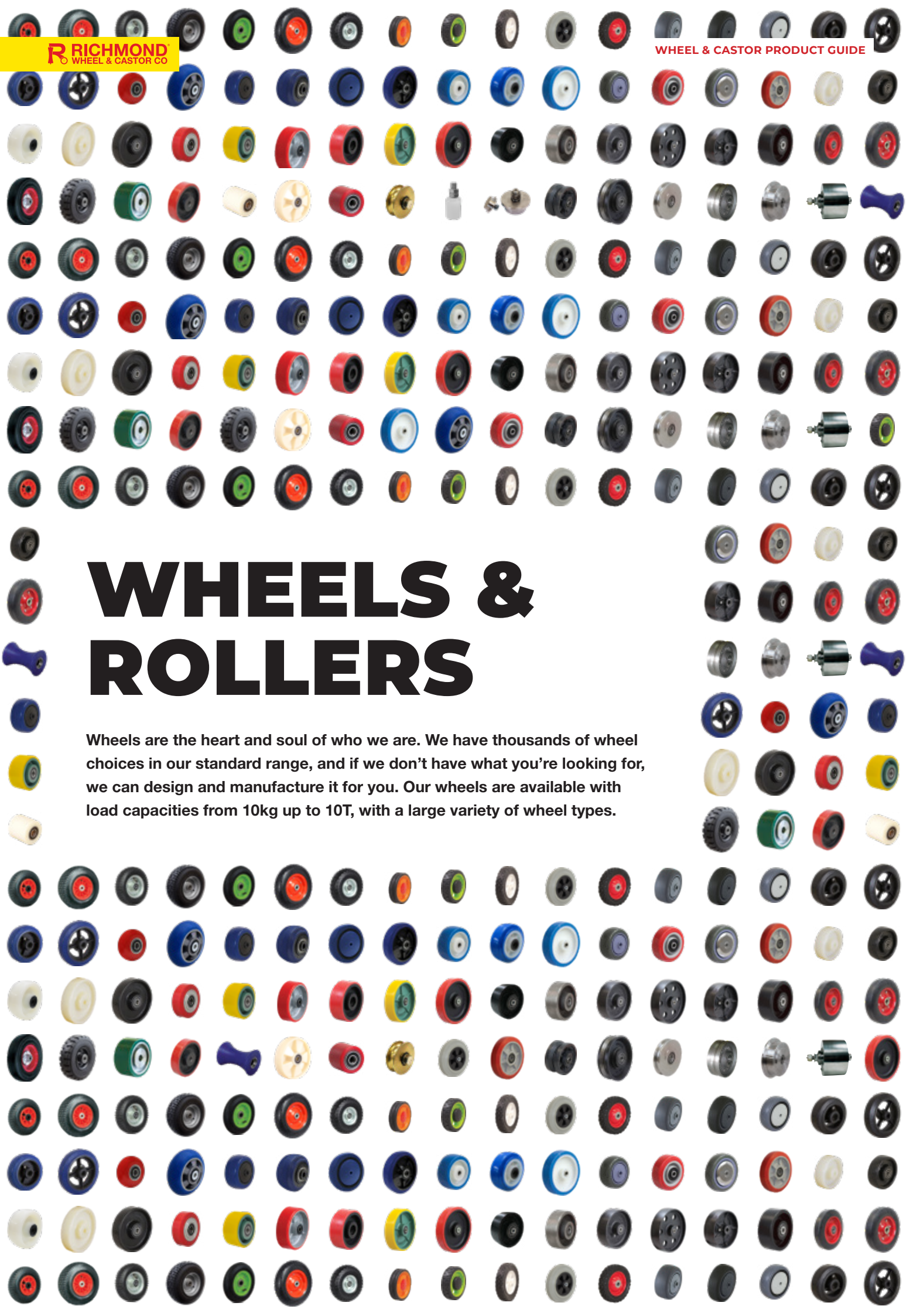

# PNEUMATIC WHEELS PLASTIC CENTRED

Plastic centred pneumatic wheels feature a quality corrosion and rust resistant plastic rim, making them ideal for applications in wet or damp environments. They are suitable for use on nursery trolleys, hand trucks, agricultural equipment and more. They are an economical alternative to steel-rimmed pneumatics.

- Plastic rim for use in wet or damp environments
- Diameters ranging from 150mm to 400mm



PN1610



PN6125



PN8864



PN1075



PN1604

 Nom Wheel Diameter (mm)	 Tyre Width (mm)	 Boss Width (mm)	 Axle Diameter	 Bearing Type	 Tyre Size	 Tyre Tread Pattern	 Load Capacity (kg)	 Wheel Code
150	29	34	1/2"	Ball	-	-	60	PN6125
160	50	50	1/2"	Ball	-	-	60	PN6200
215	60	62	5/8", 3/4"	Nylon Bush	2.50-4	Lug	100	PN8864
215	60	62	5/8, 3/4", 20mm	Flange	2.50-4	Lug	100	PN8865
265	88	60	5/8", 3/4", 20mm	Nylon Bush	4.10/3.50-4	Diamond	100	PN1074
265	88	60	5/8 or 3/4", 20mm	Flange	4.10/3.50-4	Diamond	100	PN1075
420	150	106	1"	Nylon Bush	16x6.50-8	Turf	200	PN1604
420	150	106	20mm, 25mm, 1", 3/4"	Flange	16x6.50-8	Turf	200	PN1610
400	100	105	1"	Nylon Bush	4.00-8	Knobby	200	PN1603
400	100	105	20mm, 25mm, 1", 3/4"	Flange Ball	4.00-8	Knobby	200	PN1627

## Tread Types

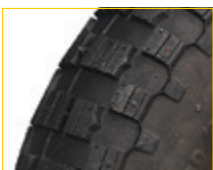

Knobby Tread



Lug Tread



Diamond Tread



Turf Tread

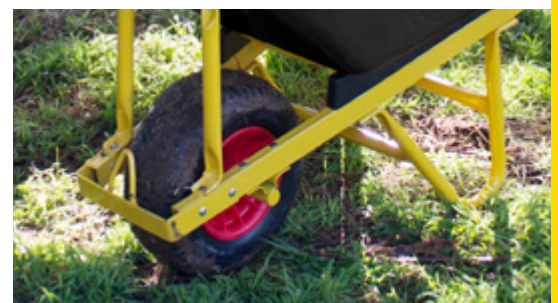

PN1610 in use on a Richmond WBR105 plastic tray wheelbarrow

# PNEUMATIC WHEELS STEEL CENTRED











PN1080-75

Steel centred pneumatic wheels are ideal for use in garden, industrial and agricultural equipment, as well as on concrete mixers. They are manufactured with one piece or three piece rims.

The 1 piece rims are powder coated and fitted with flange ball bearings. Our premium wheels are zinc plated, fitted with precision bearings and come with 3 piece rims for superior strength and durability.

- Diameters ranging from 210mm to 400mm
- Six tread patterns

 Nom Wheel Diameter (mm)	 Tyre Width (mm)	 Boss Width (mm)	 Axle Diameter	 Bearing Type	 Tyre Size	 Tyre Tread Pattern	 Load Capacity (kg)	 Wheel Code
210	60	60	5/8", 3/4" or 20mm	Ball	2.50-4	Lug	100	PN8860
215	60	60	3/4"	Flange Ball	2.50-4	Lug	100	PN8826
215	60	60	5/8", 3/4" or 20mm	Ball	2.50-4	Lug	100	PN8870
260	83	60	5/8", 3/4" or 20mm	Ball	4.10/3.50-4	Highway	180	PN1066
260	85	60	5/8", 3/4" or 20mm	Ball	4.10/3.50-4	Saw Tooth	180	PN1050
260	80	60	20mm, 25mm, 1", 3/4"	Flange Ball	4.10/3.50-4	Diamond	180	PN1080
320	83	60	20mm, 25mm, 1", 3/4"	Flange Ball	4.10/3.50-6	Highway	180	PN1271
320	120	60	20mm, 25mm, 1", 3/4"	Flange Ball	13/5.00-6	Turf	200	PN1272
400	100	75	20mm, 25mm, 1", 3/4"	Flange Ball	4.00-8	Knobby	200	PN1608
400	100	75	1"	Ball	4.00x8	Knobby	200	PN1607
400	150	75	1"	Ball	16x6.50x8	Turf	200	PN1658
400	100	94	20mm, 1" or 25mm	Ball	4.00-8	Highway	300	PN1616*
400	100	100	20mm, 25mm	Taper	4.00-8	Highway	300	PN1616TR*
400	150	75	1"	Ball	16x6.50x8	Turf	200	PN1658
400	100	94	20mm, 1" or 25mm	Ball	4.00-8	Highway	300	PN1616*
400	100	100	20mm, 25mm	Taper	4.00-8	Highway	300	PN1616TR*

## Tread Types



Knobby Tread



Lug Tread



Saw Tooth



Diamond Tread



Highway Tread



Turf Tread

# PUNCTURE PROOF WHEELS

Puncture proof wheels are filled with foam instead of air, eliminating the possibility of punctures and flat tyres. They are a tough and reliable choice for use on nursery trolleys, hand trucks, wheelbarrows and other rolling equipment. They are available with steel or plastic rims to suit different applications.

- Foam filled tyres eliminate flats
- Plastic or steel rims
- Four tread patterns



UP TO  
**200KG**  
CAPACITY

PF1275



PF8881













PF1275



PF1642



PF1628

 Nom Wheel Diameter (mm)	 Tyre Width (mm)	 Boss Width (mm)	 Axle Diameter	 Bearing Type	 Tyre Size	 Tyre Tread Pattern	 Load Capacity (kg)	 Wheel Centre	 Wheel Code
215	55	60	1/2", 5/8", 3/4" or 20mm	Ball	2.50 - 4	Lug	100	Steel	PF8881
255	83	60	1/2", 5/8", 3/4" or 20mm	Ball	4.10/3.50-4	Industrial	100	Steel	PF1084
310	81	62	1", 3/4", 25mm, 20mm	Flange Ball	4.10/3.50-6	Diamond	180	Steel	PF1273
310	103	62	1", 3/4", 25mm, 20mm	Flange Ball	13/5.00-6	Turf	200	Steel	PF1275
400	150	102	1", 3/4", 25mm, 20mm	Flange Ball	16x6.50-8	Turf	200	Plastic	PF1628*
400	93	76	1", 3/4", 25mm, 20mm	Flange Ball	4.00-8	Industrial	200	Steel	PF1632*
400	150	102	1"	Nylon Bush	16x6.50-8	Turf	200	Plastic	PF1629
400	93	76	1"	Nylon Bush	4.00-8	Industrial	200	Steel	PF1641
400	100	75	1"	Ball	400x8	Knobby	200	Steel	PF1642
400	150	75	1"	Ball	16x6.50-8	Turf	200	Steel	PF1659
400	150	75	1"	Ball	16x6.50-8	Turf	200	Steel	PF1659

## Tread Types

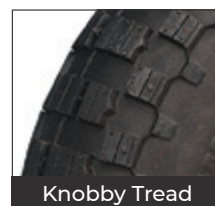
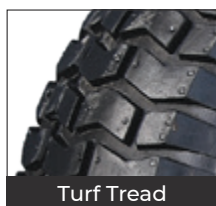
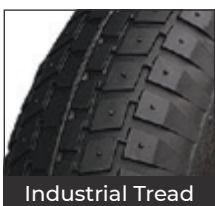

**NO  
MORE  
FLATS**



# OFFSET PNEUMATIC WHEELS

These pneumatic wheels are suitable for use on most hand trolleys with offset hub.

They are available with either 54mm or 60mm offset boss widths.



PN1070



Reverse View



 Nom Wheel Diameter (mm)	 Tyre Width (mm)	 Boss Width (mm)	 Axle Diameter	 Bearing Type	 Tyre Size	 Tyre Tread Pattern	 Load Capacity (kg)	 Wheel Code
210	60	60 offset	3/4"	Ball	2.50-4	Lug	100	PN8872
260	26	60 offset	5/8, 3/4", 20mm	Flange Ball	2.50-4	Diamond	100	PN1012
260	85	54 offset	5/8", 3/4", 20mm	Ball	4.10/3.50-4	Highway	180	PN1070
260	85	54 offset	5/8, 3/4", 20mm	Flange	4.10/3.50-4	Industrial	100	PN1071
280	60	60 offset	5/8, 3/4", 20mm	Flange	2.50-6	Industrial	150	PN1100

# OFFSET PUNCTURE PROOF WHEELS

These wheels offer the convenience of a flat-free puncture proof wheel, but with an offset hub to suit most hand trolleys where this is a requirement.

They are available with either 54mm or 60mm offset boss widths.



PF1047



 Nom Wheel Diameter (mm)	 Tyre Width (mm)	 Boss Width (mm)	 Axle Diameter	 Bearing Type	 Tyre Size	 Tyre Tread Pattern	 Load Capacity (kg)	 Wheel Code
200	60	35 offset	3/4"	Flange Ball	250x4	Lug	100	PF8827
200	80	50 offset	3/4"	Flange Ball	4.10x3.50x4	Industrial	100	PF1072
215	55	60 offset	5/8", 3/4" or 20mm	Ball	2.50 - 4	Lug	100	PF8881
255	85	54 offset	5/8", 3/4" or 20mm	Ball	4.10/3.50-4	Industrial	100	PF1047
280	60	60 offset	3/4"	Flange ball	2.50-6	Industrial	100	PF1124
330	90	76 offset	5/8"	flange Ball	400x6	Industrial	100	PF1301

# INDUSTRIAL TYRES & TUBES

## INDUSTRIAL TYRES

Size	Tread Pattern	Tyre Code
2.50-4	Lug	TYR1000
2.50-6	Industrial	TYR1010
4.10/3.50-4	Highway	TYR1020
4.10/3.50-6	Highway	TYR1030
13x5.00-6	Turf	TYR1040
4.00-8	Knobby	TYR1050
15x6.00-6	Turf	TYR1060
16x6.50-8	Turf	TYR1070
18x8.50-8	Turf	TYR1080
20x10.00x8	Turf	TYR1090

To order a tube to suit, simply change the first 3 letters of the part number. For example: to find a tyre to suit a **TYR1000** 2.50-4 tyre, just change the first 3 letters from **TYR** to **TBE** so that the **TYR1000** tyre becomes a **TBE1000** tube.

## INDUSTRIAL TUBES

To Suit Tyre Size	Tube Code
2.50-4	TBE1000
2.50-6	TBE1010
4.10/3.50-4	TBE1020
4.10/3.50-6	TBE1030
13x5.00-6	TBE1040
4.00-8	TBE1050
16x6.50-8	TBE1070
18x8.50-8	TBE1080



TYR1040



TYR1070



TBE1000



TBE1050

# BALLOON BEACH WHEELS











**UP TO 80KG CAPACITY**

BEACH16-1

Balloon beach wheels are made from polyurethane and are ideal for use over soft sand, mud, gravel, grass and rock. They can also handle harder surfaces such as concrete footpaths and roads. They are commonly seen on wheelchairs and other mobility equipment.

- For use on soft and uneven terrain
- Commonly seen on wheelchairs and beach carts
- Plastic rust-free hub

 Diameter (mm)	 Wheel Width (mm)	 Boss Width (mm)	 Wheel Material	 Bearing Type	 Axle Diameter	 Load Capacity (kg)	 Wheel Code
250	120	74	Polyurethane	Plain bore	20mm	55	BEACH10-20
300	185	175	Polyurethane	Plain bore	1"	55	BEACH12-1
400	215	174	Polyurethane	Plain bore	1"	80	BEACH16-1



**Please note:** Beach wheels are designed to be inflated to a rating of 2-4 PSI only. They are meant to be slightly squishy like a balloon. A bicycle pump is best for inflation. Compressed air can be used but care must be taken to ensure the wheels are not over-inflated.

# PUNCTURE PROOF NYLON BEACH WHEELS

These wheels are ideal for use over rough and uneven terrain, and due to their solid nylon construction, will not puncture. They are commonly seen on kayak trolleys and other marine equipment.

- For use on rough and uneven terrain
- Commonly seen on kayak trolleys and marine equipment
- Solid nylon construction

 Diameter (mm)	 Wheel Width (mm)	 Boss Width (mm)	 Wheel Material	 Bearing Type	 Axle Diameter	 Load Capacity (kg)	 Wheel Code
300	104	79	Nylon	Plain	1"	40	PF1104
300	147	117	Nylon	Plain	1"	50	PF1105
400	95	77	Nylon	Plain	1"	50	PF1695



PF1105-1

**Axles & Axle Mounting Kits to Suit Available**



**Available in 1" and 20mm Diameters**

# RUBBER/ PVC TYRED WHEELS



Rubber and PVC tyred wheels are an excellent low-cost, lightweight and durable solution for outdoor use. They are non-marking and due to their plastic construction, ideal for wash-down applications and prolonged outdoor exposure. They are commonly seen on barbecues, lawn mowers, billy carts, children’s buggies and more.

- For prolonged outdoor exposure
- Lightweight and durable



RN6629-50



RN4069-10



RN4068-08

Knock on retaining axle caps are available and provide an easy fixing arrangement.

- To suit 3/8 shaft: 100AXLECAP350
- To suit 5/8 shaft: 100AXLECAP625
- To suit 3/4 shaft: 100AXLECAP750
- To suit 1/2 shaft: 100AXLECAP50



RN8830-50



RN8884-50



RN5041-10



RN6630-50



Wheel Diameter (mm)	Tyre Width (mm)	Boss Width (mm)	Axle Diameter	Bearing Type	Load Capacity (kg)	Wheel Code
95	30	29	8mm	Plain	10	RN4068-08
107	30	30	10mm	Plain	12	RN4069-10
130	21	29	10mm	Plain	15	RN5041-10
150	42	40	1/2"	Flange	35	RN6630-50
155	42	37	1/2"	Plain	25	RN6629-50
180	35	35	1/2"	Plain	35	RN8883-50
197	45	40	1/2"	Flange	40	RN8884-50

# RUBBER TYRED NYLON CENTRED WHEELS

These wheels have a rust-free nylon plain bore, making them an ideal choice for permanent outdoor settings. They are commonly seen on outdoor furniture, barbecues and nursery trolleys.

- For permanent outdoor exposure
- Solid rubber wheel
- Rust-free nylon centre



RN6661

Wheel Diameter (mm)	Tyre Width (mm)	Boss Width (mm)	Axle Diameter	Bearing Type	Load Capacity (kg)	Wheel Code
150	37	37	1/2"	Plain	50	RN6661-50
200	42	37	1/2"	Plain	50	RN8874-50

# SEMI-PNEUMATIC RUBBER TYRED WHEELS

These semi-pneumatic rubber tyred wheels have excellent shock absorbing and puncture proof qualities.

They are commonly seen on portable equipment, steam cleaners, nursery trolleys, compressors and portable welders.

- Puncture proof construction
- Low rolling resistance
- Quiet operation



SP6663

Wheel Diameter (mm)	Tyre Width (mm)	Boss Width (mm)	Axle Diameter	Bearing Type	Load Capacity (kg)	Wheel Code
150	35	40	1/2"	Flange Ball	45	SP6663
200	42	51	1/2"	Flange Ball	70	SP8885

# RUBBER TYRED NYLON WHEELS









These rubber wheels have a nylon centre which makes them highly resistant to corrosion. They are lightweight while still maintaining a high load bearing capacity. Rubber tyred nylon wheels are a low-cost alternative to rubber tyred cast iron wheels.

- Lightweight with high load capacity
- Corrosion resistant



RN8875



 Wheel Diameter (mm)	 Tyre Width (mm)	 Boss Width (mm)	 Axle Diameter	 Bearing Type	 Load Capacity (kg)	 Tyre Colour	 Wheel Code
200	35	64	1/2" or 20mm	Roller	200	Black	RN8875
200	35	64	1/2" or 20mm	Roller	200	Grey	RN8876

# RUBBER TYRED CAST IRON CENTRED WHEELS

These wheels have a cast iron centre which results in extra strength and ease of movement. They also offer a cushioned ride, are shock absorbing and are fitted with roller bearings.

Blue tyres in this range are non-marking with high resilience, while black tyres in this range are harder wearing and will therefore last longer.

- Extra strong cast iron centres
- Quiet operation
- Non-marking or hard-wearing wheels











RT5547



RT6642



 Wheel Diameter (mm)	 Tyre Width (mm)	 Boss Width (mm)	 Axle Diameter	 Bearing Type	 Load Capacity (kg)	 Wheel Colour	 Wheel Code
100	50	64	1/2" or 3/4"	Roller	110	Black	RT4447
125	50	64	1/2" or 3/4"	Roller	180	Black	RT5547
150	50	64	1/2" or 3/4"	Roller	225	Blue	RT6642
150	50	64	1/2" or 3/4"	Roller	225	Black	RT6647
200	50	64	1/2" or 3/4"	Roller	250	Blue	RT8842
200	50	64	1/2" or 3/4"	Roller	250	Black	RT8847

# INSTITUTIONAL RUBBER WHEELS







This range of grey rubber wheels are non-marking and feature sealed bearings with matching grey nylon threadguards for added protection. Models marked with \* come with chrome threadguards which are ideal for use in hospitals, schools, home use and light industrial applications.

- Non-marking grey rubber wheels
- Sealed threadguards for protection
- Commonly seen used in institutions



IR4007



 Wheel Diameter (mm)	 Tyre Width (mm)	 Boss Width (mm)	 Axle Diameter	 Bearing Type	 Load Capacity (kg)	 Wheel Code
50	20	41	1/4"	Ball	30	IR2201
75	30	41	5/16", 3/8", 8mm	Ball	80	IR3008
75	25	25	1/4", 6mm	Ball	50	IR3301
100	32	41	5/16", 3/8", 8mm	Ball	80	IR4007
100	32	41	5/16"	Ball	80	IR4004
100	27	27	5/16" or 8mm	Ball	80	IR4401*
125	32	41	5/16", 8mm	Ball	80	IR5004*
125	32	41	5/16" or 3/8"	Ball	80	IR5007
150	32	39.6	5/16", 8mm	Ball	80	IR6009

# ANTI-STATIC RUBBER WHEELS







Anti-Static Rubber Wheels provide a surface resistivity of less than 10,000  $\Omega$  (OHM). The resistance can increase as a result of mechanical influence. The wheels conform to AS 2050 1978.

The wheels in this range are grey rubber with a nylon centre. Wheels marked with an \* feature a black rubber tyre with a chrome centre. We also produce a large range of anti-static (conductive) polyurethane wheels.



AS5005



 Wheel Diameter (mm)	 Tyre Width (mm)	 Boss Width (mm)	 Axle Diameter	 Bearing Type	 Load Capacity (kg)	 Wheel Code
100	32	41	5/16", 8mm	Ball	80	AS4005
100	32	41	5/16", 8mm	Ball	80	AS4006*
125	32	41	5/16", 8mm	Ball	80	AS5005
125	32	41	5/16", 8mm	Ball	80	AS5006*

# REBOUND RUBBER WHEELS







These wheels are non-marking, quiet, shock absorbing and have a low rolling resistance. They are ideal for moving lightly loaded equipment over uneven ground.

Rebound rubber wheels roll over small obstructions easily, and are commonly seen on waste bins, laundry trolleys, electrical equipment and other 'handle with care' goods. Stainless steel bearing models are also available.

- High shock absorbing qualities
- Non-marking
- Corrosion resistant models available



RR4473

 Wheel Diameter (mm)	 Tyre Width (mm)	 Boss Width (mm)	 Axle Diameter	 Bearing Type	 Load Capacity (kg)	 Wheel Code
75	30	41	8mm or 3/8"	Ball	80	RR3348
75	32	41	8mm or 3/8"	SS Ball	80	RR3367
75	30	39	1/2"	Plain	100	RR3370
100	30	41	8mm or 3/8"	Ball	100	RR4473
100	32	41	8mm or 3/8"	SS Ball	100	RR4367
100	30	39	1/2"	Plain	100	RR4470
100	35	46	8mm, 3/8", 12mm	Ball	150	RR4077
100	50	65	1/2" or 20mm	Ball	200	RR4078
125	30	42	8mm or 3/8"	Ball	100	RR5573
125	32	42	8mm or 3/8"	SS Ball	100	RR5637
125	30	39	1/2"	Plain	100	RR5570
125	35	46	8mm, 3/8" or 12mm	Ball	150	RR5077
125	50	65	1/2" or 20mm	Ball	250	RR5078
150	45	65	1/2" or 20mm	Ball	300	RR6677
200	45	65	1/2" or 20mm	Ball	300	RR8871



RR3367



RR5078



RR8871







# ELASTIC RUBBER WHEELS

Elastic rubber wheels are quiet, shock absorbing and provide a cushioned ride for fragile loads. They manoeuvre well over small obstacles, and have a strong resistance to wear and tear. These wheels are not recommended for applications where solvents are present.

- Ideal for fragile loads
- Quiet and shock absorbing
- Corrosion resistant models with threadguards available



ER4368

 Wheel Diameter (mm)	 Tyre Width (mm)	 Boss Width (mm)	 Axle Diameter	 Bearing Type	 Load Capacity (kg)	 Wheel Code
75	32	41	8mm or 3/8"	Ball	80	ER3368
100	32	41	8mm or 3/8"	Ball	100	ER4368
125	32	42	8mm or 3/8"	Ball	100	ER5368
230	50	57	20 or 25mm	Ball	250	ER1009

# REBOUND POLY TYRED WHEELS







These wheels have a softer than normal tyre, which provides a smoother, quieter ride than most polyurethane or nylon wheels.

The attractive sky blue tyre will remain cleaner than other types and when combined with stainless steel bearings, these wheels are suitable for clean rooms and other applications where aesthetics and performance are crucial.

- Soft and quiet riding
- Tyres remain cleaner than other wheels



RP8072

 Wheel Diameter (mm)	 Tyre Width (mm)	 Boss Width (mm)	 Axle Diameter	 Bearing Type	 Load Capacity (kg)	 Wheel Code
100	35	47	15mm or 3/8"	SS Roller	200	RP4072
100	50	63	3/4" or 1/2"	SS Roller	250	RP4073
100	35	50	15mm or 3/8", 1/2"	SS Ball	200	RP4075
125	35	47	15mm or 3/8"	SS Roller	200	RP5072
125	50	63	3/4" or 1/2"	SS Roller	250	RP5073
125	35	50	15mm or 3/8", 1/2"	SS Ball	200	RP5075
150	50	63	20mm or 1/2"	SS Roller	300	RP6072
200	50	63	20mm or 1/2"	SS Roller	300	RP8072

# DONUT PROFILE POLY TYRED ALUMINIUM CENTRED WHEELS







These polyurethane tyred aluminium centred wheels require **20% less force to move than comparative wheels**. The reactive polyurethane wheel tread is chemically and mechanically moulded on to a lightweight aluminium centre.

- 20% less force to move
- Lightweight aluminium centre



PU815



 Wheel Diameter (mm)	 Tyre Width (mm)	 Boss Width (mm)	 Axle Diameter	 Bearing Type	 Load Capacity (kg)	 Wheel Code
75	30	32	12mm	Ball	150	<b>PU349</b>
100	50	66	1/2" or 20mm	Ball	150	<b>PU436</b>
125	50	66	1/2" or 20mm	Ball	200	<b>PU536</b>
150	50	66	1/2" or 20mm	Ball	200	<b>PU636</b>
200	50	66	1/2" or 20mm	Ball	250	<b>PU815</b>



PU349

## HEAVY INDUSTRIAL CASTORS WITH DONUT PROFILE WHEELS

Castors with **Swivel Lock & Brake** or **Directional Lock** also available



S4372

R4373

S5372

R5373

S6626

R6627

S8824

R8825

## 500 SERIES CASTORS WITH DONUT PROFILE WHEELS

Castors with **Swivel Lock & Brake** or **Directional Lock** also available



S6016

R6017

S8020

R8021



# CROWNED POLY TYRED ALUMINIUM CENTRED WHEELS

Crowned polyurethane wheels offer a much lower rolling resistance compared to traditional flat treaded wheels. They are constructed from a quiet running polyurethane tyre around a lightweight aluminium centre.

They have a high resistance to chemicals and abrasive wear, and feature precision ball bearings for extended bearing life.

- Lower rolling resistance
- Quiet running
- High resistance to chemicals & abrasive wear



PU807

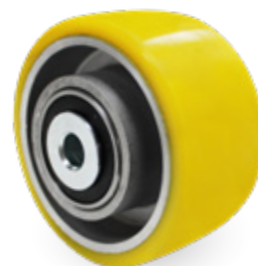

PU407

Wheel Diameter (mm)	Tyre Width (mm)	Boss Width (mm)	Axle Diameter	Bearing Type	Load Capacity (kg)	Wheel Code
100	50	63	1/2" or 20mm	Ball	300	PU407
125	50	63	1/2" or 20mm	Ball	400	PU507
150	50	63	1/2" or 20mm	Ball	500	PU607
200	50	63	1/2" or 20mm	Ball	600	PU807

## HEAVY INDUSTRIAL CASTORS WITH CROWNED POLY WHEELS

Castors with **Swivel Lock & Brake** or **Directional Lock** also available



S4274    R4275    S5274    R5275    S6274    R6275    S8274    R8275

## 500 SERIES CASTORS WITH CROWNED POLY WHEELS

Castors with **Swivel Lock & Brake** or **Directional Lock** also available



S4246    R4247    S5246    R5247    S6020    R6021    S8020    R8021

# POLY TYRED NYLON CENTRED WHEELS

UP TO  
**600KG**  
CAPACITY









PU6071

These wheels are manufactured from injection moulded polyurethane around a nylon hub. They are hard wearing, non-marking and long lasting with high load carrying abilities.

These wheels are suitable for intermittent use only. If your application required continuous running usage, our engineering department can recommend more suitable polyurethane tyres.

- Hard wearing and non-marking
- High load capacities
- For intermittent use only

 Wheel Diameter (mm)	 Tyre Width (mm)	 Boss Width (mm)	 Axle Diameter	 Bearing Type	 Load Capacity (kg)	 Wheel Code
75	30	41	8mm	SS Ball	80	PU3345
75	30	41	8mm or 10mm	Ball	80	PU3344
100	30	41	8mm	SS Ball	100	PU4439
100	30	41	8mm or 3/8"	Ball	100	PU4444
100	35	49	3/8" 1/2" or 3/4"	Roller	250	PU4408
100	50	63	1/2", 3/4" or 20mm	Ball	250	PU4409
125	27	41	8mm	SS Ball	100	PU5539
125	27	41	8mm or 3/8"	Ball	100	PU5555
125	35	49	3/4", 3/8" or 1/2"	Roller	250	PU5508
125	50	63	1/2", 3/4" or 20mm	Ball	350	PU5509
150	30	41	8mm	Ball	100	PU6660
150	50	63	1/2", 5/8, 3/4" or 20mm	Ball	400	PU6071
200	50	63	1/2", 5/8, 3/4" or 20mm	Ball	400	PU8071
200	50	48	20mm, 25mm or 1"	Ball	600	PU8074
200	50	63	3/4"	Roller	700	PU8079



PU4408



PU5555









PU8071



# POLY TYRED CAST IRON CENTRED WHEELS

These polyurethane tyred cast iron centred wheels have a hardness ranging from 60A to 75D on the shore scale. They are suitable for intermittent use only. If your application requires continuous running usage, our engineering department can recommend more suitable polyurethane tyres. Special tyres and other polyurethane parts are manufactured in-house.

 Wheel Diameter (mm)	 Tyre Width (mm)	 Boss Width (mm)	 Axle Diameter	 Bearing Type	 Load Capacity (kg)	 Wheel Code
75	25	34	1/2"	Ball	240	PU350
100	50	64	1/2" or 3/4"	Roller	250	PU424
100	50	63	1/2", 3/4", 5/8", 17mm or 20mm	Ball	500	PU425
100	38	45	3/8" or 1/2"	Ball	330	PU449
125	50	64	1/2" or 3/4"	Roller	250	PU524
125	50	64	1/2", 3/4", 5/8", 17mm, 20mm	Ball	500	PU525
125	38	48	3/8" or 1/2"	Ball	330	PU549
150	50	64	1/2" or 3/4"	Roller	250	PU614
150	75	82	20mm, 25mm, 30mm, 1"	Ball	1500	PU615
150	50	64	1/2", 5/8, 17mm, 20mm	Ball	600	PU649
150	50	64	20mm, 25mm, 1"	Ball	900	PU659
200	50	63	1/2", 3/4", 5/8", 17mm, 20mm	Ball	600	PU849
200	50	66	20mm, 25mm, 30mm, 1"	Ball	1200	PU876
200	75	82	20mm, 25mm, 30mm, 40mm or 1"	Ball	1500	PU896
200	75	90	20mm, 25mm, 3/4"	Ball	1500	PU824
200	75	82	20mm, 25mm, 1", 30mm	Ball	3000	PU823
200	84	96	40MM	Taper/Ball	5000	PU890
250	50	66	20mm, 25mm or 50mm	Ball	1500	PU1056
250	75	82	20mm, 25mm, 30mm, 1"	Ball	1500	PU1076
250	75	88	20mm	Ball	2000	PU1030
250	75	82	20mm	Ball	2500	PU1029
250	100	112	40mm	Ball	5000	PU1048
250	100	112	40mm	Taper	5000	PU1049
300	100	112	50mm	Ball	4000	PU1207
300	72	82	20mm 25mm 30mm	Ball	3000	PU1217
300	50	66	20mm	Ball	1300	PU1218
300	100	112	25mm, 30mm or 40mm	Ball	3000	PU1224
300	100	112	40mm	Ball	5000	PU1203
300	100	112	40mm	Ball	5000	PU1238
400	125	137	40mm	Taper	5000	PU1606
400	125	137	40mm	Ball	5000	PU1666



PU424



PU449



PU615



PU876

# DRIVE WHEELS

Drive wheels are polyurethane tyred with a hardness of 85A on the shore scale. The cast iron centre is bored to provide a transition fit onto a shaft.

These drive wheels are stocked without keyways cut, but if your application requires keyways we can supply on request. These wheels are suitable for intermittent use only. If your application requires continuous running usage, our engineering department can recommend more suitable polyurethane tyres.

- 85A shore scale hardness
- Available with keyways cut on request

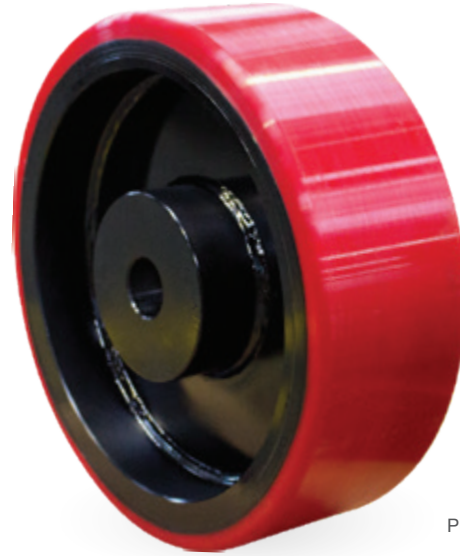

PU1800DV

 Wheel Diameter (mm)	 Tyre Width (mm)	 Boss Width (mm)	 Axle Diameter	 Bearing Type	 Load Capacity (kg)	 Wheel Code
150	75	76	25mm	Plain	900	<b>PU615DV</b>
150	50	63	25mm	Plain	500	<b>PU659DV</b>
200	50	63	25mm	Plain	700	<b>PU876DV</b>
200	75	76	25 to 40mm	Plain	900	<b>PU896DV</b>
250	100	112	50mm	Plain	5000 (57D)/ 3750 (90A)	<b>PU1049DV</b>
250	50	60	25 to 50mm	Plain	1200 (57D)/ 900(90A)	<b>PU1056DV</b>
250	75	76	25 to 40mm	Plain	1100	<b>PU1076DV</b>
300	100	102	50mm	Plain	2000	<b>PU1207DV</b>
300	75	76	25 to 50mm	Plain	1000	<b>PU1217DV</b>
400	125	137	50mm	Plain	2800	<b>PU1606DV</b>
450	150	152	50mm	Plain	3500	<b>PU1800DV</b>

All wheel options can be supplied to order with any bore sizes, keyway, spline or shaft locking element. Assembly may be required.



PU659DV

PU876DV

PU1076DV

# HIGH/LOW TEMPERATURE WHEELS



These glass-filled nylon, cast iron, aluminium or high temp polymer wheels are commonly seen on bakery ovens, smoke houses, chillers or applications where there is temperature fluctuation and exposure from -30° to +350°C with peaks up to 400°C.

Aluminium models AL472 and AL473 are fitted with DU Teflon bushes for noiseless ease of use, while AL471 and AL474 are fitted with aluminium bronze bushes for extremely high temperatures.

All wheels can be fitted to a variety of castor frames. Get in touch with our team for a more comprehensive evaluation of your requirements.



AL473

 Wheel Diameter (mm)	 Tyre Width (mm)	 Wheel Type	 Boss Width (mm)	 Axle Diameter	 Bearing Type	 Load Capacity (kg)	 Temperature Range	 Wheel Code
75	32	Cast Iron	38	1/2"	Plain	150	-30° to 300°C	<b>Ci3340</b>
100	31	High Temp Polymer	38	1/2 or 5/16	Oiless Du Bush	200	-20° to 280°C	<b>HT480</b>
100	40	High Temp Polymer	45	1/2 or 3/8	Oiless Du Bush	200	-20° to 280°C	<b>HT481</b>
100	35	Glass Filled Nylon	45	20mm	Plain	200	-30° to 240°C	<b>GF412</b>
100	30	Glass Filled Nylon	37	1/2"	Plain	200	-30° to 240°C	<b>GF4420</b>
100	36	Aluminium	40	5/16", 1/2"	Bronze Bush	200	-30° to 400°C	<b>AL471</b>
100	36	Aluminium	40	5/16", 1/2"	Oiless Du Bush	200	-30° to 280°C	<b>AL472</b>
100	36	Aluminium	46	3/8", 1/2"	Oiless Du Bush	200	-30° to 280°C	<b>AL473</b>
100	36	Aluminium	46	3/8", 1/2"	Bronze Bush	200	-30° to 400°C	<b>AL474</b>
100	38	Cast Iron	45	1/2"	Plain	300	-30° to 300°C	<b>Ci421</b>
125	38	Cast Iron	45	1/2"	Plain	380	-30° to 300°C	<b>Ci532</b>
150	45	Glass Filled Nylon	57	3/4"	Plain	400	-30° to 240°C	<b>GF652</b>
150	45	Cast Iron	60	1/2", 3/4"	Plain	500	-30° to 300°C	<b>Ci611</b>
150	50	SG Iron	60	5/8"	Plain	500	-30° to 300°C	<b>SG608</b>
200	43	Glass Filled Nylon	60	20mm, 1/2"	Plain	40	-30° to 240°C	<b>GF800</b>
200	50	Cast Iron	60	3/4"	Plain	600	-30° to 300°C	<b>Ci842</b>



SG608



GF652



Ci421



HT480

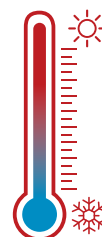









Wheels to suit temps from -30° to +350°C with peaks up to 400°C.

# SOLID NYLON WHEELS

These wheels are constructed from virgin nylon and are fully conditioned in an industrial sauna for maximum strength. They are an easy to maintain and durable wheel with low rolling resistance. They are high wearing when compared to equivalent sized rubber wheels. These solid nylon wheels are available in black or white.

- Conditioned for maximum strength
- Plain bore models suitable for wash-down applications
- Available in black or white



 Wheel Diameter (mm)	 Tyre Width (mm)	 Boss Width (mm)	 Axle Diameter	 Bearing Type	 Load Capacity (kg)	 Colour	 Wheel Code
50	20	22	5/16"	Plain	50	White	NY204
75	25	28 incl. sleeve	6 or 8mm	Plain	50	Black	NY3324
75	30	41	5/16" or 1/2"	Plain	125	White	NY3321
100	35	47	1/2", 3/4", 3/8"	Plain	300	White or Black	NY401
100	50	64	1/2" or 3/4"	SS Roller	300	White	NY404
100	35	42	3/8" or 1/2"	Ball	300	Black	NY413
100	26	34 incl. sleeve	8mm, 6mm	Plain	70	Black	NY4415
100	30	41	5/16" or 1/2"	Plain	125	White	NY4417
125	35	47	1/2", 3/4", 3/8"	Plain	350	White or Black	NY501
125	50	64	1/2 or 3/4"	Plain	300	White	NY504
125	35	48	3/8" or 1/2"	Ball	330	Black	NY513
125	30	41	5/16" or 1/2"	Plain	125	White	NY5517
150	50	64	1/2", 5/8", 3/4" or 20mm	Ball	400	Black	NY613
150	50	64	1/2" or 20mm	SS Ball	400	Black	NY635
150	50	60	1/2", 3/4", 20mm or 7/8"	Plain	400	White or Black	NY652
150	45	45	1/2", 3/4"	Plain	250	White	NY653
150	50	60	1/2", 3/4"	SS Roller	400	White	NY655
200	50	60	3/4", 20mm or 7/8", 1/2"	Plain	400	White or Black	NY800
200	50	63	1/2", 20mm	SS Roller	500	White	NY802
200	50	65	1/2", 5/8", 3/4" or 20mm	Ball	400	Black	NY830
200	50	64	1/2" or 20mm	SS Ball	400	Black	NY854

To specify wheels in black or white add **BLK** or **WHT** to the end of the part number. For example **NY501BLK** is a 100mm black nylon wheel, and **NY501WHT** is a 100mm white nylon wheel.







# POLYURETHANE & NYLON ROLLERS

These polyurethane and nylon rollers are commonly used as replacement parts for pallet jacks and other equipment. They offer good wear resistance, and are available in a number of sizes and configurations. Our engineering department can custom design and manufacture rollers for printing and press applications.

- Replacement parts for pallet jacks & equipment
- Good wear resistance



PU410

 Wheel Diameter (mm)	 Tyre Width (mm)	 Boss Width (mm)	 Wheel Type	 Axle Diameter	 Bearing Type	 Load Capacity (kg)	 Wheel Code
80	96	96	Polyurethane	20mm	Ball	800	PU324
80	96	96	Nylon	20mm	Ball	800	NY335
82	100	100	Polyurethane	20 or 25mm	Ball	500	PU326
82	82	82	Polyurethane	20 or 25mm	Ball	450	PU341
82	75	75	Polyurethane	20 or 25mm	Ball	450	PU325
82	65	65	Polyurethane	20 or 25mm	Ball	400	PU340
82	100	100	Nylon	20 or 25mm	Ball	800	NY417
82	82	82	Nylon	20 or 25mm	Ball	600	NY418
100	75	75	Polyurethane	20 or 25mm	Ball	600	PU410
200	50	48	Polyurethane	20 or 25mm	Ball	600	PU8074
200	50	48	Nylon	20 or 25mm	Ball	600	NY832
200	50	56	Polyurethane	20mm	Ball	600	PU820
200	50	56	Nylon	20mm or 25mm	Ball	600	NY833



NY833

# CAST IRON & SG IRON WHEELS



Both cast iron and spheroidal graphite iron wheels provide a high capacity with low rolling resistance. They are hard wearing as well as abrasive and heat resistant.

They can be used for high load bearing applications in which loads are left standing for extended periods, as they will always be ready to roll due to their low rolling resistance.

- High load capacity
- Low rolling resistance
- Abrasive and heat resistant

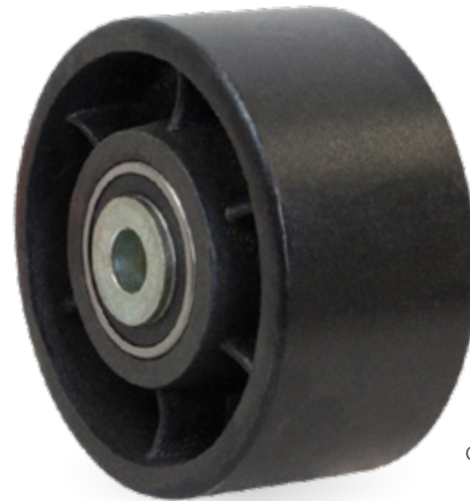







CI689



CI842

## CAST IRON WHEELS

 Wheel Diameter (mm)	 Tyre Width (mm)	 Boss Width (mm)	 Axle Diameter	 Bearing Type	 Load Capacity (kg)	 Wheel Code
75	32	40	1/2"	Plain	100	CI3340
100	38	48	1/2"	Plain	300	CI421
100	50	66	1/2" 5/8" 3/4" 20mm	Ball	750	CI464 *
100	38	49	1/2" or 3/8"	Ball	400	CI400
125	38	48	1/2"	Plain	380	CI532
125	45	66	5/8"	Ball	650	CI520
150	45	66	1/2", 3/4"	Plain	600	CI611
150	75	82	20 or 25 mm	Ball	1670	CI689
150	45	66	1/2", 5/8", 3/4" & 20mm	Ball	1000	CI601
200	50	62	3/4"	Plain	600	CI842
200	50	66	1/2", 20 or 25mm	Ball	1000	CI852

## SG IRON WHEELS

 Wheel Diameter (mm)	 Tyre Width (mm)	 Boss Width (mm)	 Axle Diameter	 Bearing Type	 Load Capacity (kg)	 Wheel Code
150	50	60	5/8"	Plain	500	SG607
200	75	90	20mm, 25mm	Ball	1500	SG822
200	75	82	20mm, 25mm	Ball	2000	SG834
200	50	66	20 or 25mm	Ball	1800	SG835 *
200	75	90	20mm, 25mm	Ball	2000	SG821
200	75	96	40mm, 30mm, 25mm	Taper/Ball	5000	STG836 *
250	75	90	20mm, 25mm	Ball	1500	SG1027
250	75	82	20mm, 25 mm	Ball	1800	SG1040
250	75	82	20mm, 25mm	Ball	2000	SG1028



SG821







# CUSHION RUBBER WHEELS

These wheels can withstand high impact while still offering a soft ride. The steel centre adds additional strength while quality elastic rubber compound tyres result in a softer, shock absorbing ride.

- Soft, shock absorbing ride
- Can withstand high impact



CR1060

 Wheel Diameter (mm)	 Tyre Width (mm)	 Boss Width (mm)	 Axle Diameter	 Bearing Type	 Load Capacity (kg)	 Wheel Code
230	40	50	12mm, 1/2", 3/4", 20mm, 25mm	Ball	220	CR9000
250	50	55	12mm, 1/2", 3/4", 20mm, 25mm	Ball	300	CR1060
280	50	53	20mm, 25mm or 1"	Ball	200	CR1110







# SOLID PNEUMATIC WHEELS

These wheels are puncture proof for long wear, and feature split pins with rugged bolt-on hubs. The unique formulation of these solid pneumatic wheels provides the performance of a pneumatic tyre but with a much higher load capacity. They are towable up to 24kph and are ideal for tarmac use.

- Towable up to 24kph
- Puncture proof
- High load capacity



SN1612

 Wheel Diameter (mm)	 Tyre Width (mm)	 Boss Width (mm)	 Axle Diameter	 Bearing Type	 Load Capacity (kg)	 Wheel Code
250	75	93	20mm, 25mm	Ball	260	SN1005
300	83	93	20mm, 25mm, 1"	Ball	540	SN1295
400	110	94	20mm, 25mm, 1"	Ball	950	SN1612
400	123	PCD	N/A	Ball	1050	SN1619

\*SN1005 and SN1295 solid pneumatic wheels are only towable for speeds up to 12kph

# CONCRETE AGITATOR & TRUNNION ROLLERS











AGR003









These concrete agitator rollers are designed for small to large concrete trucks. They are suitable for all trommel applications with nylon and aluminium rollers made to order.

A full range of spare parts are available for these rollers.









## MINI ROLLER - USED FOR 3 METRE MINI CONCRETE TRUCKS

 Roller Diameter (mm)	 Rim Width (mm)	 Dist b/w Flats (mm)	 Flat Width (mm)	 Flat Depth (mm)	 Flat Diameter (mm)	 Axle Length (mm)	 Load Capacity (kg)	 Roller Code
152	75	105	10	5	26.5	154		AGR003

## JTY ROLLER - USED FOR 4 TO 6 METRE MINI CONCRETE TRUCKS

 Roller Diameter (mm)	 Rim Width (mm)	 Dist b/w Flats (mm)	 Flat Width (mm)	 Flat Depth (mm)	 Flat Diameter (mm)	 Axle Length (mm)	 Load Capacity (kg)	 Roller Code
208	92	158.5	12.75	5.5	32.5	216		AGR002

## MAXI ROLLER - USED FOR 6 TO 8 METRE LARGE CONCRETE TRUCKS

 Roller Diameter (mm)	 Rim Width (mm)	 Dist b/w Flats (mm)	 Flat Width (mm)	 Flat Depth (mm)	 Flat Diameter (mm)	 Axle Length (mm)	 Load Capacity (kg)	 Roller Code
197	121	160	18	4.45	31.8	237		AGR001



# TRACK WHEELS SINGLE FLANGE

Single flange wheels are designed to run on railway line. They are made from cast iron to suit your application, with axle shafts available.









Track wheels can be flame hardened to increase wear resistance, and are also available as drive wheels. These wheels can also be used on other sections such as RHS.



SF1099



TRACK WHEELS - SINGLE FLANGE

 Wheel Diameter (mm)	 Rim Width (mm)	 Flange Width (mm)	 Flange Diameter (mm)	 Boss Width (mm)	 Axle Diameter	 Bearing Type	 Load Capacity (kg)	 Wheel Code
75	45	10	100	61	20 or 25mm	Ball	750	SF399
100	25	10	120	41	3/4"	Plain	375	SF499
100	25	10	120	44	1/2"	ball	375	SF499
100	50	20	130	76	20 or 25mm	Ball	1300	SF492
100	25	10	120	48	1/2"	Ball	375	SF499
150	40	9	175	59	3/4" or 25mm	Plain	1000	SF699
154	50	20	192	82	25mm	Ball	2000	SF697
150	40	9	175	59	5/8" or 20mm	Ball	1000	SF699
200	50	14	225	70	25 to 50mm	Plain	1800	SF899
200	39	16	228	61	35mm	Ball	1100	SF891
200	50	14	225	70	20, 25, or 40mm	Ball	1100	SF899
250	50	15	290	71	25 or 50mm	Plain	1800	SF1099
250	52	12	285	81	45mm	Ball	2400	SF1098
250	50	15	290	71	20, 25, 30, or 40mm	Ball	2400	SF1099
250	50	15	290	71	20mm to 50mm	Plain	2400	SF1099
300	52	14	360	101	50mm	Ball	4000	SF1299



# TRACK WHEELS DOUBLE FLANGE

Double flange wheels are often used where accurate tracking is needed. They are manufactured using K1045 steel, and can be matched with a flat rim wheel to guide on one side of the track only.

Axle shafts are available upon request. These wheels can be flame hardened to increase wear resistance, and are also available as drive wheels.



DF698











 Wheel Diameter (mm)	 Rim Width (mm)	 Flange Width (mm)	 Flange Diameter (mm)	 Boss Width (mm)	 Axle Diameter	 Bearing Type	 Load Capacity (kg)	 Wheel Code
125	27	15	150	66	20 or 25mm	Ball	1300	DF698
150	52	10.5	178	80	30mm	Ball	1800	DF795
175	52	12	200	82	30mm	Ball	2800	DF895
225	52	14	250	89	30 or 50mm	Ball	4000	DF1095
250	62	19	300	106	50mm	Ball	5000	DF1295

# TRACK WHEELS BEAM TROLLEY

These beam trolley wheels have been designed to fit standard channel and beam sections. They are manufactured using K1045 steel, making them strong and reliable track wheels.



BT80

 Wheel Diameter (mm)	 Rim Width (mm)	 Flange Width (mm)	 Flange Diameter (mm)	 Axle Length (mm)	 Shoulder Length (mm)	 Axle Diameter	 Bearing Type	 Load Capacity (kg)	 Wheel Code
48	14	5	61	17	2	1/2" UNF	Ball	65	BT481
58	27	12	79	25	3	16mm (M16)	Ball	200	BT581
80	27	12	100	30	3	20mm (M20)	Ball	250	BT80
100	32	8	134	35	3	24mm (M24)	Ball	500	BT493

We can custom design and manufacture track wheels to your specifications. Contact our team to find out more.





# TRACK WHEELS V GROOVE



VG459

These V groove track wheels are CNC machined from cast iron, K1045 steel or SG iron. They are suitable for running track wheels on bars, pipes, angle iron or rope.

Capacities can be increased with changes to bearing and shaft configurations. Our engineering department can also design and manufacture V groove track wheels to your specifications.

 Wheel Diameter (mm)	 Rim Width (mm)	 Boss Width (mm)	 Groove Width (mm)	 Groove Depth (mm)	 Axle Diameter	 Bearing Type	 Wheel Type	 Load Capacity (kg)	 Wheel Code
75	32	38	22	10.8	1/2"	Plain	Cast Iron	65	VG360
100	36	41	22	10.8	3/4"	Plain	Cast Iron	280	VG459
100	36	41	22	10.8	3/8" or 1/2"	Ball	Cast Iron	280	VG459
100	50	60	22	12	1/2" or 3/4"	Roller	Cast Iron	300	VG461
150	38	60	22	10.8	1/2" 5/8" 3/4" or 20mm	Ball	K1045 Steel	650	VG609
150	50	60	22	12	1/2" or 3/4"	Roller	Cast Iron	450	VG661
200	52	60	30	14.7	20 or 25mm	Ball	SG Iron	1300	VG839
200	75	96	30	14.7	40mm	Taper/Ball	K1045 Steel	5000	VG836
250	52	60	30	14.7	20, 25, 30mm	Ball	K1045 Steel	2000	VG1059









# TRACK WHEELS ROPE GROOVE



RG458

These rope groove track wheels are CNC machined from cast iron, K1045 steel or SG iron. They are suitable for running track wheels on bars, pipes, angle iron or rope.

Capacities can be increased with changes to bearing and shaft configurations. Our engineering department can also design and manufacture rope groove track wheels to your specifications.

 Wheel Diameter (mm)	 Rim Width (mm)	 Boss Width (mm)	 Suit Rope Diameter (mm)	 Axle Diameter	 Bearing Type	 Load Capacity (kg)	 Wheel Code
100	25	30	8	1/2", 5/8" or 20mm	Ball	500	RG458
150	32	40	12	20mm or 25mm	Ball	1500	RG658

# TRACK WHEELS C GROOVE

These C groove track wheels are CNC machined from cast iron, K1045 steel or SG iron. They are suitable for running track wheels on bars, pipes, gate tracks, angle iron or rope.

Capacities can be increased with changes to bearing and shaft configurations. Our engineering department can also design and manufacture rope groove track wheels to your specifications.



GTR009



Wheel Diameter (mm)	Rim Width (mm)	Boss Width (mm)	Suit Bar	Axle Diameter	Bearing Type	Wheel Type	Load Capacity (kg)	Wheel Code
78	28	34	20	14	Ball	Steel	350	GTR006
88	28	34	20	14	Ball	Steel	380	GTR007
98	28	34	20	14	Ball	Steel	400	GTR008
100	36	41	16 or 20	3/8" or 1/2"	Ball	Ci Iron	280	CG459
116	28	34	20	14	Ball	Steel	420	GTR009

## BOTTOM MOUNT EXTERNAL TRACK WHEELS

D (mm)	A (mm)	B (mm)	C (mm)	D1 (mm)	E (mm)	F (mm)	G (mm)	Wheel Type	Load Capacity (kg)	Product Code
78	23	85	20.5	60	35	70	100	Steel	250	GTR001
88	23	96	20.5	70	36	105	130	Nylon	250	GTR238
88	23	96	20.5	70	36	105	130	Stainless Steel	250	GTR239
98	23	106	20.5	70	36	105	130	Steel	250	GTR093
118	30	127	20.5	100	42	130	158	Steel	400	GTR002



GTR001

GTR238 and GTR239 feature a grade 304 stainless steel frame with dual 2RS grade 440 SS bearings.

## RECESSED TRACK WHEELS

D (mm)	A (mm)	B (mm)	C (mm)	D1 (mm)	E (mm)	F (mm)	G (mm)	Wheel Type	Load Capacity (kg)	Product Code
78	23	19	20.5	60	32	110	135	Steel	250	GTR003
88	24	14.5	20.5	70	34	128	152	Steel	250	GTR004
88	24	14.5	20.5	70	34	128	152	Nylon	250	GTR236
88	24	14.5	20.5	70	34	128	152	Stainless Steel	250	GTR237
98	24	19.5	20.5	80	34	128	152	Steel	300	GTR005



GTR003

GTR236 and GTR237 feature a grade 304 stainless steel frame with dual 2RS grade 440 SS bearings.

Bottom Mount Track Wheels

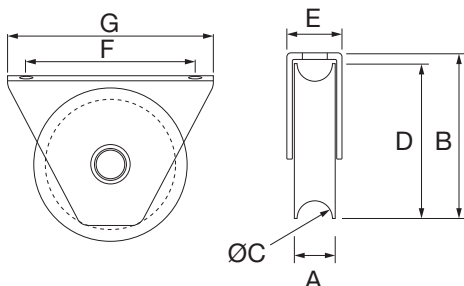

Recessed Track Wheels

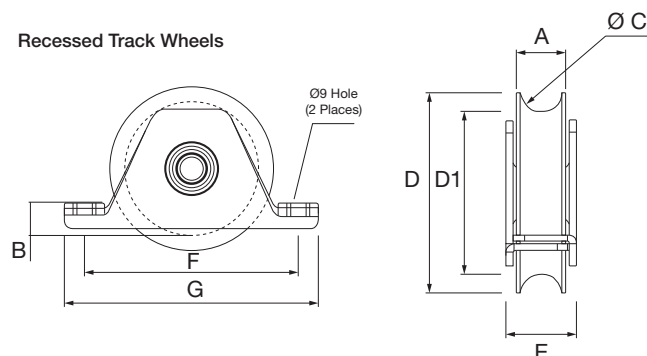

# BALL TRANSFER UNITS



Ball transfers enable the smooth and simple transfer of objects in any direction. These ball transfers consist of a large load bearing roller sitting upon many smaller balls encapsulated in a cup. Where moving heavy loads is paramount, multi-directional movement is essential. These ball transfers are commonly used around presses, guillotines and packing machines. They make for perfect transfer stations from one conveyor to another.

Richmond can customise ball transfer tables to suit your application.

## Square Flange Mount Ball Transfer 38.1mm Roller Diameter

Load Capacity: 90kg  
Overall Height: 45mm  
Hole Centres: 62mm  
Mounting Hole Diameter: 7mm



Mild Steel: BTR638MS  
Stainless Steel: BTR638SS

## Double Flange Mount Ball Transfer 15.8mm Roller Diameter

Load Capacity: 10kg  
Overall Height: 21mm  
Hole Centres: 40mm  
Mounting Hole Diameter: 4mm



Mild Steel: BTR116MS  
Stainless Steel: BTR116SS

## Double Flange Mount Ball Transfer 25.4mm Roller Diameter

Load Capacity: 35kg  
Overall Height: 30mm  
Hole Centres: 56mm  
Mounting Hole Diameter: 5.5mm



Mild Steel: BTR125MS  
Stainless Steel: BTR125SS

## Recessed Flange Mount Ball Transfer 15.8mm Roller Diameter

Load Capacity: 15kg  
Overall Height: 19.5mm  
Hole Centres: 31mm  
Mounting Hole Diameter: 4mm



Mild Steel: BTR216MS  
Stainless Steel: BTR216SS

## Recessed Flange Mount Ball Transfer 22.225mm Roller Diameter

Load Capacity: 25kg  
Overall Height: 26mm  
Hole Centres: 40mm  
Mounting Hole Diameter: 4mm



Mild Steel: BTR222MS  
Stainless Steel: BTR222SS

## Recessed Flange Mount Ball Transfer 25.4mm Roller Diameter

Load Capacity: 15kg  
Overall Height: 19.5mm  
Hole Centres: 31mm  
Mounting Hole Diameter: 4mm



Mild Steel: BTR225MS  
Stainless Steel: BTR225SS

## Threaded Ball Transfer 15.8mm Roller Diameter

Load Capacity: 35kg  
Thread Size: M10 x 17mm  
Overall Height: 51mm



Mild Steel: BTR325MS  
Stainless Steel: BTR325SS

## Drop in Stamped Style Ball Transfer 15.8mm Roller Diameter

Load Capacity: 13kg  
Overall Height: 21mm  
Flange Diameter: 31mm  
Base Diameter: 24mm



Mild Steel: BTR416MS  
Stainless Steel: BTR416SS

## Drop in Stamped Style Ball Transfer 22.225mm Roller Diameter

Load Capacity: 30kg  
Overall Height: 30mm  
Flange Diameter: 45mm  
Base Diameter: 36mm



Mild Steel: BTR422MS  
Stainless Steel: BTR422SS

## Drop in Stamped Style Ball Transfer 25.4mm Roller Diameter

Load Capacity: 35kg  
Overall Height: 38mm  
Flange Diameter: 47.02mm  
Base Diameter: 38.5mm



Mild Steel: BTR425MS  
Stainless Steel: BTR425SS

## Drop in Machined Style Ball Transfer 25.4mm Roller Diameter

Load Capacity: 200kg  
Overall Height: 38mm  
Flange Diameter: 45mm  
Base Diameter: 38mm



Mild Steel: BTR525MS  
Stainless Steel: BTR525SS

## Drop in Machined Style Ball Transfer 30mm Roller Diameter

Load Capacity: 250kg  
Overall Height: 36.5mm  
Flange Diameter: 55mm  
Base Diameter: 45mm



Mild Steel: BTR530MS  
Stainless Steel: BTR530SS

We can custom design and manufacture ball transfer tables to suit any specification. Contact our team to find out more.

# FLOW RAILS

Flow rail systems are gravity driven and ideal for applications where picking and stock turnover is frequent.

They reduce manual handling, by presenting on a stock rotation basis as inventory flows on a first-in-first-out system. They can be easily incorporated into racking or custom framing, providing unlimited solutions in the manufacturing industry.



FRR002

Length (m)	Roller Diameter (mm)	Roller Width (mm)	Frame Width (mm)	Overall Height (mm)	Skate Type	Load Capacity Per Metre (kg)	Model Number
3	28	25	40	39	Nylon	20	FRR001
3	32	25	36	36	Nylon	60	FRR002
3	13	17	29	23	Nylon	10	FRR010

# SKATE RAILS

Skate rails are a heavy duty alternative to flow rails, and are suitable for heavy industrial loads, pallets and larger, robust cartons.

They are free-flowing and gravity driven. They are designed to reduce costs by reducing manual handling.



FRR003



FRR005

Length (mm)	Roller Diameter (mm)	Width (mm)	Pitch (mm)	Skate Type	Load Capacity (kg)	Model Number
3000	50	16	Single 75	Nylon	750 *	FRR005
3000	50	16	Single 75	Steel	1500 *	FRR004
3000	50	16	Double 75	Steel	1400 *	FRR003

\*Load capacity is based on the skate rail supported every metre.

## SKATE RAIL WHEELS

Diameter (mm)	Material	Load Capacity (kg)	Bore size (mm)	Boss Width (mm)	Rim width (mm)	Model Number
48.5	Nylon	60	8	18	16	SKW001
49	Steel	15	8	20	15	SKW002



SKW001



SKW003

# CONVEYOR ROLLERS

Richmond Gravity Conveyor Rollers allow free moving, efficient and safe transportation of goods at any operational stage of a conveyor line. Producing movement via natural forces, gravity conveyors are an economical material handling solution used in many industries for simplicity and functionality.

Spring-loaded shafts provide hassle free maintenance and simple installation. They ensure secure attachment to the conveyor frame (channel) maximising roller and bearing function and performance. Rollers are available in zinc plated steel, nylon and stainless steel for wash down applications.

It is recommended that there be a minimum of three rollers under the goods being transported at any one time. The size of the object being transported can help determine the roller pitch on your conveyor system applying the three roller rule.

Richmond can custom manufacture gravity conveyor rollers to length, diameter and shaft requirements.



Face Width (A) (mm)	Tyre Width (C) (mm)	Over Bearing Width (B) (mm)	Diameter (D) (mm)	Material Type	Load Capacity (kg)	To Suit Overall Conveyor Width (mm)	Model Number
217	-	227	50	Steel	100	290	<b>CRR003</b>
206	-	227	50	Nylon	40	290	<b>CRR500</b>
377	-	387	50	Steel	100	450	<b>CRR007</b>
366	-	387	50	Nylon	40	450	<b>CRR501</b>
527	-	537	50	Steel	100	600	<b>CRR014</b>
516	-	537	50	Nylon	40	600	<b>CRR502</b>
380	380	387	56	Rubber Coated Steel	40	450	<b>CRR008</b>
530	530	537	56	Rubber Coated Steel	40	600	<b>CRR009</b>
377	360	387	60	Poly Coated Steel	100	450	<b>CRR010</b>
527	511	537	60	Poly Coated Steel	100	600	<b>CRR011</b>

We make conveyor rollers to size. Contact us to find out more.

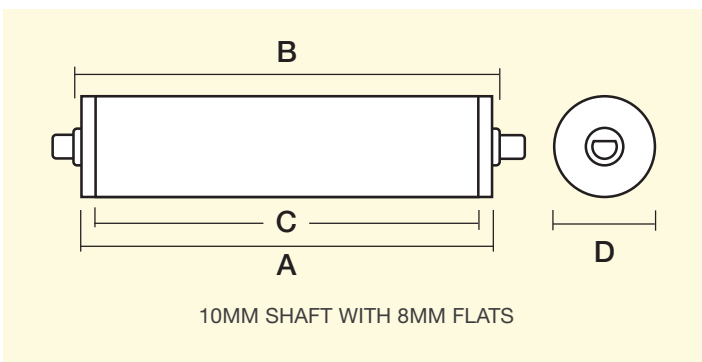

# CUSTOM CONVEYOR SOLUTIONS

## What do we offer?

- Our onsite engineers can design to any specification
- From concept through to manufacture and installation, we are with you every step of the way
- We have years of industry experience to back us up. We know conveyors - **custom solutions are what we do best.**



**No matter the application or industry, Richmond have got a solution. You name it, we've done it.**



Warehousing & Distribution



Aviation



Manufacturing



Food Processing



Agricultural



Automotive

## Why choose us?

- ✓ On-site engineers ready to tackle your project
- ✓ On-site manufacturing machinery
- ✓ Nationwide service
- ✓ 60+ years of industry experience
- ✓ 100% family owned and run



**Contact our team today to design your custom conveyor solution.**

# FLOOR LOCKS

Floor locks are designed to stop portable equipment and trolleys from moving. They are foot-operated and feature a long-lasting resilient polyurethane pad and swivel base for uneven floors.

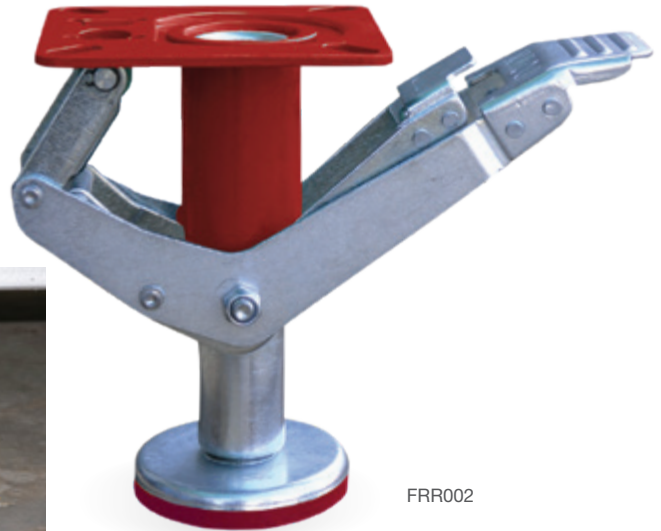

FRR002

Extended Height (mm)	Retracted Height (mm)	Stroke	Pedal Length (mm)	Floor Lock Code
155	130	25	140	900-2FL
215	170	45	145	900-4FL

## FLOOR LOCK OPERATION

1. Depress the down pedal as far as it will go. **The lock is now set.**
2. **To unlock**, press the up pedal until it is level with the down pedal. Release. The base will then retract from the floor.



## SELECTING & INSTALLING FLOOR LOCKS

- It is important to select a model which clears the floor when retracted
- To adapt a floor lock to your current equipment, select a model with an extended height 1.6mm to 6mm greater than the overall height of the castors.
- The lock must be centred between castors
- When installed the floor lock must be set 5mm from ground level when in the UP position.

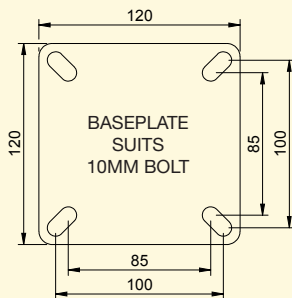

Baseplate for Richmond Floor Locks

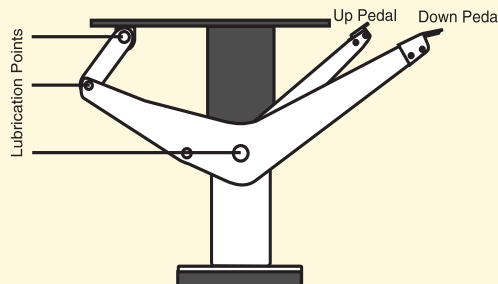

Cross Section of Richmond Floor Locks

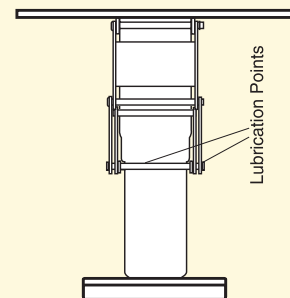

Lubrication Points

# THREADED TUBE INSERTS

## SQUARE TUBE INSERTS

Base Width (A)	Suits Tube Size	Shank Width (F)	Shank Length (C)	Overall Length (D)	Thread (B)	Load Capacity	Part Number
19	19mm square tube	16.5	28	31	M8	250	TIR19SQM08
25	25.4mm square tube	23.8	39.6	46.6	M8	250	TIR25SQM08
25	25.4mm square tube	23.8	39.6	46.6	M10	250	TIR25SQM10
25	25.4mm square tube	23.8	39.6	46.6	M12	250	TIR25SQM12
32	31.8mm square tube	30	38.4	46.4	M8	350	TIR32SQM08
32	31.8mm square tube	30	38.4	46.4	M10	350	TIR32SQM10
32	31.8mm square tube	30	38.4	46.4	M12	350	TIR32SQM12
38	38mm square tube	36.1	38.1	46.1	M10	500	TIR38SQM10
38	38mm square tube	36.1	38.1	46.1	M12	500	TIR38SQM12
38	38mm square tube	36.1	38.1	46.1	M16	500	TIR38SQM16
40	40mm square tube	36.8	38.1	47.1	M10	500	TIR40SQM10
40	40mm square tube	36.8	38.1	47.1	M12	500	TIR40SQM12
40	40mm square tube	36.8	38.1	47.1	M16	500	TIR40SQM16
51	50mm square tube	47.9	36.9	46.9	M10	750	TIR51SQM10
51	50mm square tube	47.9	36.9	46.9	M12	750	TIR51SQM12
51	50mm square tube	47.9	36.9	46.9	M16	750	TIR51SQM16
51	50mm square tube	47.9	36.9	46.9	M20	750	TIR51SQM20



For stainless steel options add SS to the part number e.g. TIR19SQM08SS

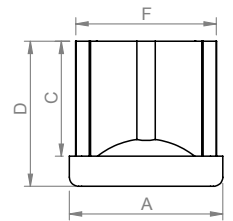
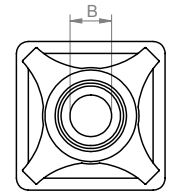

## ROUND TUBE INSERTS

Diameter (mm)	Suits Tube Size	Shank Diameter (F)	Shank Length (C)	Overall Length (D)	Thread (B)	Load Capacity	Part Number
19	19mm O.D. square tube	16	27	31	M8	50	TIR19RDM08
25	25.4mm O.D round tube	22.5	37.4	45.8	M8	100	TIR25RDM08
25	25.4mm O.D round tube	22.5	37.4	45.8	M10	100	TIR25RDM10
25	25.4mm O.D round tube	22.5	37.4	45.8	M12	100	TIR25RDM12
32	31.8mm O.D round tube	29.5	39.2	45.3	M10	250	TIR32RDM10
32	31.8mm O.D round tube	29.5	39.2	45.3	M12	250	TIR32RDM12
32	31.8mm O.D round tube	29.5	39.2	45.3	M16	250	TIR32RDM16
38	38mm O.D round tube	35.3	39.4	45.6	M10	300	TIR38RDM10
38	38mm O.D round tube	35.3	39.4	45.6	M12	300	TIR38RDM12
38	38mm O.D round tube	35.3	39.4	45.6	M16	300	TIR38RDM16
51	51mm O.D round tube	48.5	39.2	47.4	M10	450	TIR51RDM10
51	51mm O.D round tube	48.5	39.2	47.4	M12	450	TIR51RDM12
51	51mm O.D round tube	48.5	39.2	47.4	M16	450	TIR51RDM16
51	51mm O.D round tube	48.5	39.2	47.4	M20	450	TIR51RDM20



For stainless steel options add SS to the part number e.g. TIR25RDM08SS

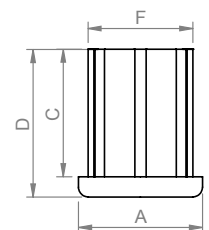
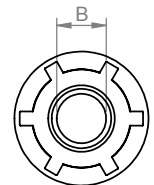

# LEVELLING FEET

## FIXED - RUBBER & STEEL BASE

Used to provide a level, stable base for tables, machinery, or equipment. Richmond's range of adjustable feet help ensure your table, workbench machinery etc. is mounted correctly and levelled on uneven surfaces. Adjustable feet also help to prevent tipping, vibration, wear and noise.

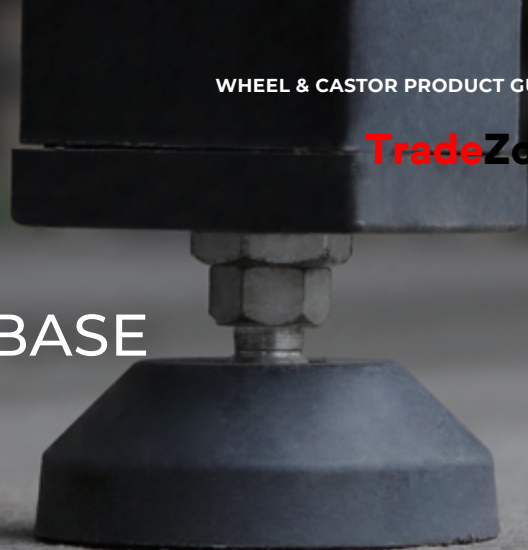

### FIXED - RUBBER BASE

Size	Base Diameter (A)	Base Height (B)	Thread Length (C)	Thread (D)	Load Capacity	Part Number
60 x M10	60mm	25mm	50mm	M10	500kg	LVR118
60 x M10	60mm	25mm	100mm	M10	500kg	LVR119
60 x M12	60mm	25mm	100mm	M12	500kg	LVR121
70 x M16	70mm	30mm	150mm	M16	500kg	LVR123
70 x M20	70mm	30mm	150mm	M20	500kg	LVR125

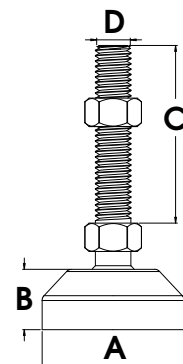

### FIXED - STEEL BASE

Size	Base Diameter (A)	Base Height (B)	Thread Length (C)	Thread (D)	Load Capacity	Part Number
38 x M8	38mm	11mm	50mm	M8	150kg	LVR088
38 x M8	38mm	11mm	100mm	M8	150kg	LVR089
38 x M10	38mm	11mm	50mm	M10	150kg	LVR090
60 x M10	60mm	11mm	100mm	M10	300kg	LVR093
60 x M12	60mm	11mm	100mm	M12	300kg	LVR095
80 x M16	80mm	13mm	100mm	M16	500kg	LVR096
80 x M20	80mm	13mm	100mm	M20	500kg	LVR098
100 x M20	100mm	20mm	150mm	M20	700kg	LVR101

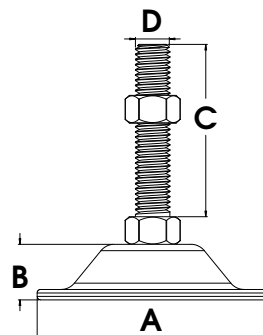

LVR118  
Fixed - Rubber Base



LVR095  
Fixed - steel base

# LEVELLING FEET

## BOLT DOWN & FIXED - RUBBER BASE

### BOLT DOWN

Size	Base Diameter (A)	Thread Height (B)	Base Thread Height (C)	Base Height (D)	Thread (E)	Hole Centres (F)	Hole Diameter (G)	Load Capacity	Part Number
80 x M8	80mm	100mm	35mm	18mm	M8	56mm	10mm	350kg	LVR8008100B
80 x M10	80mm	100mm	32mm	18mm	M10	56mm	10mm	500kg	LVR8010100B
80 x M12	80mm	100mm	33mm	18mm	M12	56mm	10mm	800kg	LVR8012100B*
80 x M12	80mm	150mm	35mm	18mm	M12	56mm	10mm	800kg	LVR8012150B
100 x M12	100mm	100mm	41mm	29mm	M12	73mm	13mm	800kg	LVR10012100B
100 x M12	100mm	150mm	44mm	29mm	M12	73mm	13mm	800kg	LVR10012150B
100 x M16	100mm	150mm	45mm	28mm	M16	73mm	13mm	1000kg	LVR10016150B
127 x M16	127mm	150mm	47mm	29mm	M16	102mm	13mm	1000kg	LVR12716150B
127 x M20	127mm	150mm	47mm	30mm	M20	102mm	13mm	1000kg	LVR12720150B

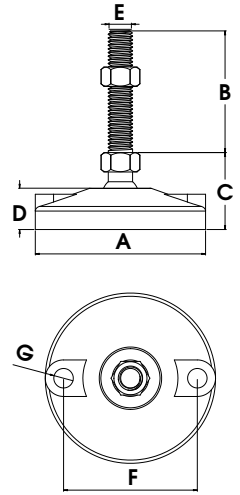

For stainless steel options add SS to the part number e.g. LVR8008100BSS. \* indicates models not available in stainless steel

### FIXED

Size	Base Diameter (A)	Thread Height (B)	Base Thread Height (C)	Base Height (D)	Thread (E)	Load Capacity	Part Number
50 x M8	50mm	50mm	31mm	23mm	M8	350kg	LVR500850F
50 x M10	50mm	50mm	31mm	23mm	M10	500kg	LVR501050F
60 x M12	60mm	50mm	33mm	25mm	M12	800kg	LVR601250F
60 x M12	60mm	100mm	33mm	25mm	M12	800kg	LVR6012100F
60 x M16	60mm	150mm	35mm	25mm	M16	1000kg	LVR6016150F
60 x M20	60mm	150mm	35mm	25mm	M20	1000kg	LVR6020150F
80 x M12	80mm	100mm	40mm	30mm	M12	500kg	LVR8012100F*
80 x M12	80mm	150mm	40mm	30mm	M12	500kg	LVR8012150F
80 x M16	80mm	150mm	40mm	30mm	M16	800kg	LVR8016150F*
80 x M20	80mm	150mm	40mm	30mm	M20	1000kg	LVR8020150F

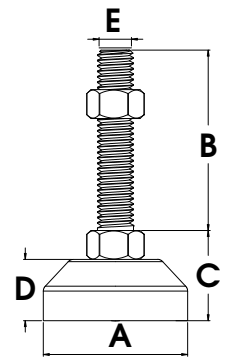

For stainless steel options add SS to the part number e.g. LVR8008100BSS. \* indicates models not available in stainless steel



# LEVELLING FEET

## BALL JOINTED - RUBBER BASE

Size	Base Diameter (A)	Thread Height (B)	Base Thread Height (C)	Base Height (D)	Thread (E)	Load Capacity	Part Number
40 x M8	40mm	50mm	30mm	17mm	M8	350kg	LVR400850S
40 x M8	40mm	100mm	33mm	17mm	M8	350kg	LVR4008100S
40 x M10	40mm	50mm	30mm	16mm	M10	500kg	LVR401050S
40 x M10	40mm	100mm	32mm	18mm	M10	500kg	LVR4010100S
60 x M8	60mm	50mm	36mm	24mm	M8	350kg	LVR600850S
60 x M10	60mm	50mm	36mm	24mm	M10	500kg	LVR601050S
60 x M10	60mm	100mm	38mm	24mm	M10	500kg	LVR6010100S
60 x M12	60mm	50mm	36mm	24mm	M12	800kg	LVR601250S
60 x M12	60mm	100mm	36mm	24mm	M12	800kg	LVR6012100S
80 x M12	80mm	50mm	36mm	24mm	M12	800kg	LVR801250S
80 x M12	80mm	100mm	36mm	24mm	M12	800kg	LVR8012100S
80 x M16	80mm	100mm	38mm	23mm	M16	1000kg	LVR8016100S
80 x M16	80mm	150mm	38mm	24mm	M16	1000kg	LVR8016150S
80 x M20	80mm	100mm	42mm	23mm	M20	1000kg	LVR8020100S
80 x M20	80mm	150mm	42mm	24mm	M20	1000kg	LVR8020150S

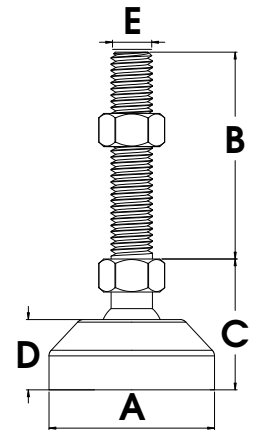

For stainless steel options add SS to the part number e.g. LVR400850SSS

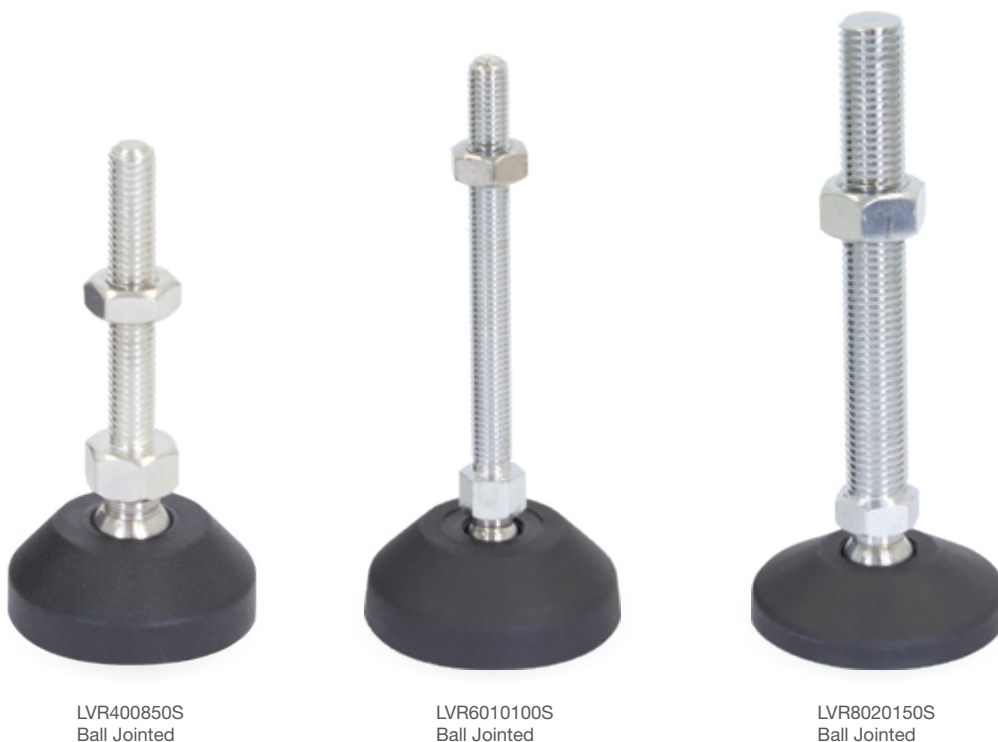

# LEVELLING FEET

## FIXED - NYLON & NYLON CONE

### NYLON KNOB

Size	Base Diameter (A)	Base Height (B)	Thread Length (C)	Thread (D)	Load Capacity	Part Number
25 x M8	25mm	10mm	50mm	M8	100kg	LVR057
38 x M8	38mm	10mm	50mm	M8	200kg	LVR059
38 x M10	38mm	10mm	50mm	M10	200kg	LVR060
50 x M10	50mm	10mm	50mm	M10	300kg	LVR062
50 x M10	50mm	10mm	100mm	M10	300kg	LVR063
50 x M12	50mm	10mm	50mm	M12	300kg	LVR064
50 x M12	50mm	10mm	100mm	M12	300kg	LVR065
63 x M10	63mm	10mm	30mm	M10	500kg	LVR066
63 x M10	63mm	10mm	100mm	M10	500kg	LVR067
63 x M12	63mm	10mm	50mm	M12	500kg	LVR068
63 x M12	63mm	10mm	100mm	M12	500kg	LVR069

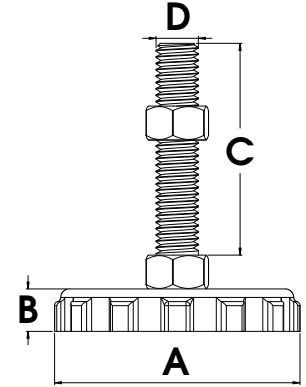

### NYLON CONE

Size	Base Diameter (A)	Base Height (B)	Thread Length (C)	Thread (D)	Load Capacity	Part Number
40 x M8	40mm	13mm	50mm	M8	100kg	LVR051
50 x M10	50mm	13mm	50mm	M10	150kg	LVR052
60 x M12	60mm	13mm	50mm	M12	200kg	LVR053

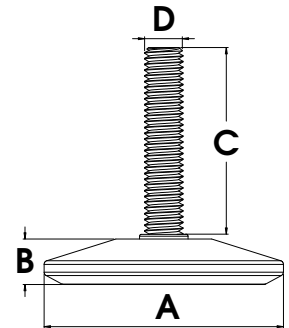

LVR057  
Nylon Knob



LVR052  
Nylon Cone

# LEVELLING FEET

## FIXED - STEEL/RUBBER & STEEL/NYLON

### FIXED - STEEL/RUBBER

Size	Base Diameter (A)	Base Height (B)	Thread Length (C)	Thread (D)	Load Capacity	Part Number
30 x M6	30mm	15mm	50mm	M6	200kg	LVR074
30 x M8	30mm	15mm	50mm	M8	200kg	LVR075
40 x M8	40mm	17mm	50mm	M8	300kg	LVR076
40 x M10	40mm	17mm	50mm	M10	300kg	LVR078
50 x M10	50mm	17mm	50mm	M10	450kg	LVR080
50 x M12	50mm	17mm	50mm	M12	450kg	LVR082
60 x M10	60mm	20mm	100mm	M10	600kg	LVR085
60 x M12	60mm	20mm	100mm	M12	600kg	LVR087

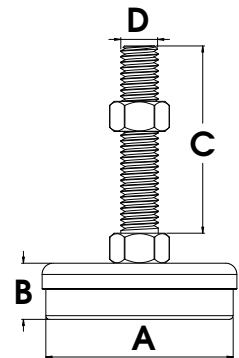

### FIXED - STEEL/NYLON

Size	Base Diameter (A)	Base Height (B)	Thread Length (C)	Thread (D)	Load Capacity	Part Number
25 x M6	25mm	10mm	25mm	M6	200kg	LVR069A
25 x M8	25mm	10mm	25mm	M8	200kg	LVR070
35 x M8	35mm	12mm	25mm	M8	300kg	LVR071
35 x M10	35mm	12mm	45mm	M10	350kg	LVR072
40 x M10	40mm	14mm	45mm	M10	500kg	LVR073A
40 x M10	40mm	14mm	25mm	M10	500kg	LVR073
80 x M20	80mm	13mm	100mm	M20	500kg	LVR098
100 x M20	100mm	20mm	150mm	M20	700kg	LVR101

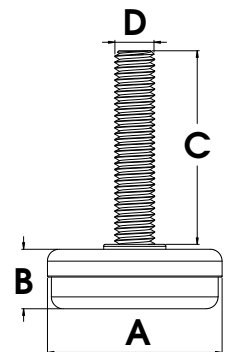

LVR082  
Fixed - Steel/Rubber Base



LVR070  
Fixed - Steel/Nylon

# END CAPS

End caps insert to fit light wall tubes.  
All models feature a ribbed design for a safe and secure fit.



ENDCP65MMSQ



ENDCP2-500RD

## SQUARE TUBE END CAPS

Tube Size	Tube Wall Thickness	Product Code
15.88 (5/8")	1.2 - 1.6	ENDCPSQ15
19.05 (3/4")	1.2 - 1.6	ENDCPSQ19
22.23 (7/8")	1.2 - 1.6	ENDCPSQ22
25.4 (1")	1.2 - 1.6	ENDCP1-000SQ
30	1.2 - 1.6	ENDCP30MMSQ
31.75 (1.25")	1.25 - 1.6	ENDCP1-250SQ
38.1 (1.5")	1 - 2.5	ENDCP1-500SQ
40	1 - 3	ENDCP40MMSQ
50	1.6 - 3	ENDCP50MMSQ
65	1.6 - 4	ENDCP65MMSQ
75	2 x 4.5	ENDCP75MMSQ
100	1.6 - 4	ENDCP100MMSQ

## ROUND TUBE END CAPS

Tube Size	Tube Wall Thickness	Product Code
15.87 (5/8")	1.2 - 1.6	ENDCP-625RD
19.05 (3/4")	1.2 - 1.6	ENDCP-750RD
22.22 (7/8")	1.2 - 1.6	ENDCP-875RD
25.4 (1")	1.2 - 1.6	ENDCP1-000RD
28.575 (1.125")	1.2 - 1.6	ENDCP1-125RD
31.75 (1.25")	1.2 - 1.6	ENDCP1-250RD
38.1 (1.5")	1.2 - 1.6	ENDCP1-500RD
50.8 (2")	1.2 - 1.6	ENDCP2-000RD
63.5 (2.5")	1.2 - 1.6	ENDCP2-500RD
75mm(3")	3.2 - 5m	ENDCP3-00RND



ENDCP75X50



ENDCP-THR001

## RECTANGLE TUBE END CAPS

Tube Size	Tube Wall Thickness	Product Code
50 x 25	1.6 - 1.8	ENDCP50X25
70 x 25	1 - 3	ENDCP75X25
75 x 50	2.5 - 4.5	ENDCP75X50
100 x 50	2 - 4	ENDCP100X50
150 x 50	2 - 4	ENDCP150X50

## THREADED SQUARE TUBE END CAPS

Tube Size	Thread Size	Tube Wall Thickness	Product Code
25.4 (1")	3/8" BSW	1.2 - 1.6	ENDCP-THR001
31.275 (1.25")	3/8" BSW	1.6	ENDCP-THR002

# SLEEVES & REDUCTION TOP HATS

Richmond's range of sleeves are most commonly used inside roller bearings or plain bore wheels for castors.

A range of top hats are available to reduce precision bearing sizes. Mild steel axles are available from Richmond to suit our wheel range. Axles are easily cut to length to suit any application.



## SLEEVES - MILD STEEL

OD (A)	ID (B)	Length(C)	Product Code
3/4"	3/8"	48.5	SL137
3/4"	1/2"	63.5	SL142
3/4"	1/2"	101	SL143
3/4"	1/2"	82	SL144
1/2"	3/8"	48	SL165UG
20mm	1/2"	64.8	SL151
1/2"	8mm	41	SL148
1/2"	3/8"	41	SL202

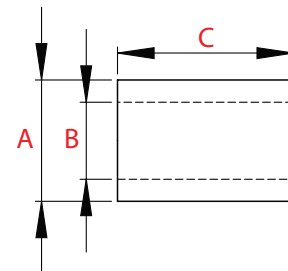
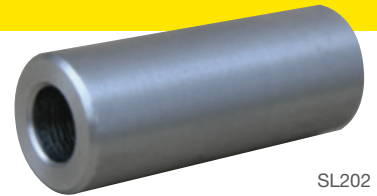

## SLEEVES - STAINLESS STEEL

OD (A)	ID (B)	Length(C)	Product Code
1/2"	8mm	41	SL099
1/2"	3/8"	49.5	SL101
20mm	1/2"	63.5	SL105
3/4"	1/2"	48.5	SL106
3/4"	1/2"	63.5	SL107
3/4"	5/8"	63.4	SL108
15mm	10mm	46.5	SL118

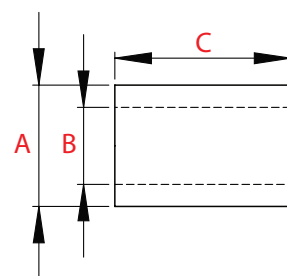
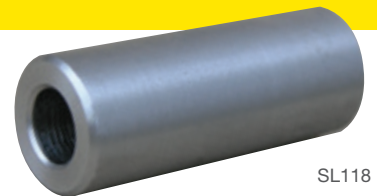

**REDUCER TOP HATS - ZINC PLATED MILD STEEL**

OD (A)	ID (B)	Length (C)	Shoulder Width	Product Code
10mm	6mm	4mm	5mm	RED1006UTI
10mm	8mm	4mm	5mm	RED1008UTI
12mm	8mm	13mm	3mm	RED1208OBT
12mm	10mm	13mm	3mm	RED1210OBT
1/2"	3/8"	20mm	3mm	RED500x37
5/8"	1/2"	27mm	3mm	RED625x50
15mm	12mm	20mm	3mm	RED15X12
15mm	1/2"	20mm	3mm	RED15X50
20mm	1/2"	29mm	3mm	RED20X12.8
20mm	5/8"	20mm	3mm	RED20X62
25.4mm	5/8"	20mm		RED25-4-62
25.4mm	3/4"	20mm	2mm	RED25-4-19
25.4mm	20	15mm	2mm	RED25-4-20
30mm	20mm	38mm	3mm	RED3020
30mm	25mm	38mm	3mm	RED3025
40mm	20mm	33mm	5mm	RED4020
40mm	25mm	33mm	5mm	RED4025



RED1208OBT

**REDUCER TOP HATS - ZINC PLATED MILD STEEL**

OD (A)	ID (B)	Length (C)	Product Code
3/4"	3/8"	15mm	NRR001
3/4"	1/2"	15mm	NRR002
3/4"	5/8"	15mm	NRR003
1"	5/8"	15mm	NRR004
1"	3/4"	15mm	NRR005
1"	20mm	15mm	NRR006
2"	20mm	17mm	NRR007



# FASTENERS - SET SCREWS

## HIGH TENSILE ZINC PLATED

Part Number	Size	Pack Qty
SETM840HPK	M8 x 40mm	4
SETM1030HPK	M10 x 30mm	4
SETM1040HPK	M10 x 40mm	4
SETM1050HPK	M10 x 50mm	4
SETM1230HPK	M12 x 30mm	4
SETM1240HPK	M12 x 40mm	4
SETM1250HPK	M12 x 50mm	4



## GRADE 304 STAINLESS STEEL

Part Number	Size	Pack Qty
SETM840SPK	M8 x 40mm	4
SETM1030SPK	M10 x 30mm	4
SETM1040SPK	M10 x 40mm	4
SETM1050SPK	M10 x 50mm	4
SETM1230SPK	M12 x 30mm	4
SETM1240SPK	M12 x 40mm	4
SETM1250SPK	M12 x 50mm	4



# FASTENERS NUTS

## HEX NUTS - ZINC PLATED

Part Number	Size	Pack Qty
NUTM8ZPK8	M8	8
NUTM10ZPK8	M10	8
NUTM12ZPK4	M12	4



## NYLON LOCK NUTS - ZINC PLATED

Part Number	Size	Pack Qty
NUTM8ZNP8	M8	8
NUTM10ZNP8	M10	8
NUTM12ZNP4	M12	4



## HEX NUTS - 304 STAINLESS STEEL

Part Number	Size	Pack Qty
NUTM8SPK8	M8	8
NUTM10SPK8	M10	8
NUTM12SPK4	M12	4



## NYLON LOCK NUTS - 304 STAINLESS STEEL

Part Number	Size	Pack Qty
NUTM8SNPK8	M8	8
NUTM10SNPK8	M10	8
NUTM12SNPK4	M12	4



## T NUTS - ZINC PLATED

Part Number	Size	Pack Qty
TNUTM8ZPK4	M8	4
TNUTM10ZPK4	M10	4
TNUTM12ZPK4	M12	4



# FASTENERS - WASHERS

## FLAT WASHER - ZINC PLATED

Part Number	Size	Pack Qty
FLWM8ZPK8	M8	8
FLWM10ZPK8	M10	8
FLWM12ZPK8	M12	8
FLWM16ZPK8	M16	8
FLWM20ZPK8	M20	8
FLW500ZPK8	1/2"	8
FLW750ZPK8	3/4"	8



## FLAT WASHER - 304 STAINLESS STEEL

Part Number	Size	Pack Qty
FLWM8SPK8	M8	8
FLWM10SPK8	M10	8
FLWM12SPK8	M12	8
FLWM16SPK8	M16	8
FLWM20SPK8	M20	8
FLW500SPK8	1/2"	8
FLW750SPK8	3/4"	8



## SPRING WASHER - ZINC PLATED

Part Number	Size	Pack Qty
SPWRM8ZPK8	M8	8
SPWRM10ZPK8	M10	8
SPWRM12ZPK8	M12	8



## SPRING WASHER - 304 STAINLESS STEEL

Part Number	Size	Pack Qty
SPWRM8SPK8	M8	8
SPWRM10SPK8	M10	8
SPWRM12SPK8	M12	8



# FASTENERS - SPLIT PINS

## SPLIT PINS - ZINC PLATED

Part Number	Size	Pack Qty
SPIN3240ZPK8	3.2 x 40mm	8
SPIN4040ZPK8	4 x 40mm	8



## SPLIT PINS - 304 STAINLESS STEEL

Part Number	Size	Pack Qty
SPIN3240SPK8	3.2 x 40mm	8
SPIN4040SPK8	4 x 40mm	8



# FASTENERS - ANCHOR BOLTS

## EXPANDING HEX ANCHOR BOLT

Part Number	Size	Pack Qty
ABL6ZPK8	M6 x 45mm	8



## NAIL-IN MUSHROOM ANCHOR

Part Number	Size	Pack Qty
NIA250ZPK8	1/4" x 1"	8
NIA380ZPK8	1/4" x 2"	8
NIA380ZPK25	1/4" x 2"	25



# PINTLE PARTS

Solid metal pintles are used to ensure castors and securely fastened into position. Solid pintles are maintenance free, and both solid and threaded metal pintles fit all of our pintle castors.

Threaded metal pintles are used when a variety of thread sizes are required. Other sizes available for quantity order.

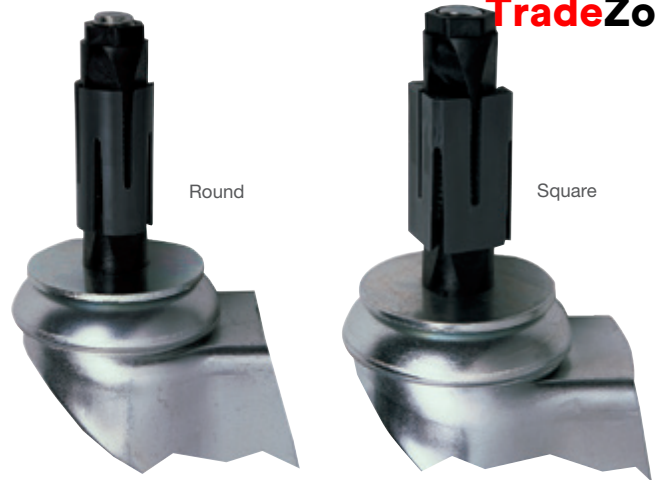

## EXPANDING PINTLE PARTS - FOR ROUND TUBE

These expanding pintles are perfect to attach our bolt hole castors into round tubular legs. These pintles are made out of nylon and come with a suitable zinc-plated or stainless steel pintle bolt.

Product Code	Suits Tube Diameter	Pintle Bolt Dimensions	Pintle Bolt Material
UTI10-P1	19mm	M10 x 90mm	Zinc Plated Steel
UTI10-P2	22mm	M10 x 90mm	Zinc Plated Steel
UTI10-P3	28.5mm	M10 x 90mm	Zinc Plated Steel
OBT12-P1	19mm	M12 x 90mm	Zinc Plated Steel
OBT12-P2	22mm	M12 x 90mm	Zinc Plated Steel
OBT12-P3	28.5mm	M12 x 90mm	Zinc Plated Steel
SSP12-P1	19mm	M12 x 90mm	Stainless Steel
SSP12-P2	22mm	M12 x 90mm	Stainless Steel
SSP12-P3	28.5mm	M12 x 90mm	Stainless Steel



OBT12-P2

## EXPANDING PINTLE PARTS - FOR SQUARE TUBE

These expanding pintles are perfect to attach our bolt hole castors into square tubular legs. These pintles are made out of nylon and come with a suitable zinc-plated or stainless steel pintle bolt.

Product Code	Suits Internal Tube Size	Pintle Bolt Dimensions	Pintle Bolt Material
UTI10-P4	19mm Square	M10 x 90mm	Zinc Plated Steel
UTI10-P5	22mm Square	M10 x 90mm	Zinc Plated Steel
UTI10-P6	28.5mm Square	M10 x 90mm	Zinc Plated Steel
OBT12-P4	19mm Square	M12 x 90mm	Zinc Plated Steel
OBT12-P5	22mm Square	M12 x 90mm	Zinc Plated Steel
OBT12-P6	28.5mm Square	M12 x 90mm	Zinc Plated Steel
SSP12-P4	19mm Square	M12 x 90mm	Stainless Steel
SSP12-P5	22mm Square	M12 x 90mm	Stainless Steel
SSP12-P6	28.5mm Square	M12 x 90mm	Stainless Steel



SSP12-P6

**THREADED METAL PINTLE PARTS**

Product Code	Pintle Thread	Hex Shoulder Height	Base Thread
SMPT-62UNC	5/8" UNC	8mm	M12 x 17mm(L)
SMPT-50BSW	1/2" BSW	8mm	M12 x 17mm(L)
SMPT-16M	16mm	8mm	M12 x 17mm(L)
SMPT-20M	20mm	8mm	M12 x 17mm(L)
TH1	12mm	8mm	12 x 28mm(L)
TH2	16mm	8mm	12 x 30mm(L)
TH3	3/4" BSW	-	12 x 30mm(L)
TH4	1/2" UNF	8mm	12 x 30mm(L)
TH5	1/2" BSW	8mm	12 x 30mm(L)
TH6	5/8" UNC	8mm	12 x 30mm(L)



SMPS-32M

**SOLID ROUND METAL PINTLE PARTS**

Product Code	Pintle Diameter	Base Thread	Tapped Through Thread
SMPR-19M	19mm	M12 x 17mm (L)	M8
SMPR-22M	22mm	M12 x 17mm (L)	M8
SMPR-28.5M	28.5mm	M12 x 17mm (L)	M8
SMPR-32M	32mm	M12 x 17mm (L)	M8



SMPR-22M







**SOLID SQUARE METAL PINTLE PARTS**

Product Code	Pintle Size	Base Thread	Tapped Through Thread
SMPS-19M	19mm Square	M12 x 17mm (L)	M8
SMPS-22M	22mm Square	M12 x 17mm (L)	M8
SMPS-28.5M	28.5mm Square	M12 x 17mm (L)	M8
SMPS-32M	32mm Square	M12 x 17mm (L)	M8



SMPS-32M

**MOUNTING FITTINGS FOR GRIP NECK FURNITURE CASTORS**

Pintle	Pintle Code	Pintle Type	To Suit Castor
	PINTLER01	For 12.7mm ID Round Tube	S055PK2
	PINTLER03	For 19.0mm ID Round Tube	S055PK2
	PINTLER04	For 22.0mm ID Round Tube	S055PK2
	PINTLER07	For 16.0mm ID Round Tube	S055PK2
	PINTLER05	Grip Neck to suit Timber	S055PK2
	PINTLES01	For 16.0mm ID Square Tube	S055PK2
	PINTLES02	For 22.0mm ID Square Tube	S055PK2
	PINTLER02	For 19.0mm ID Round Tube C/W 3/8" BSW Thread	S055PK2
	PINTLER06	For 22.0mm ID Round Tube C/W 3/8" BSW Thread	S055PK2
	PINTLES03	For 22.0mm ID Square Tube C/W 3/8" BSW Thread	S055PK2
	PINTLES04	For 19.0mm ID Square Tube C/W 3/8" BSW Thread	S055PK2

# BEARINGS

We use a lot of different types of bearings in the production and assembly of our products. With over 60 years of designing Wheels and Castors behind us, we have deep experience in the choice and use of bearings of all types.

Contact our knowledgeable team for help choosing the perfect bearing for your application.



FUB-50



62052RS-25

## FLANGE BEARINGS

Outer Diameter	Internal Diameter	Product Code
1 1/8" (28.575mm)	1/2" (12.7mm)	<b>FUB-50</b>
1 3/8" (34.925mm)	5/8" (15.875mm)	<b>FBB-62</b>
1 3/8" (34.925mm)	3/4" (19.05mm)	<b>FBB-75</b>
2" (50.8mm)	1" 25.4mm	<b>FBB-1</b>



FBB-75





## PRECISION BALL BEARINGS

Outer Diameter	Internal Diameter	Bearing Width	Seal Type	Product Code
28mm	12mm	8mm	Rubber Seal	<b>6001-2RS</b>
40mm	3/4" (19.05mm)	12mm	Rubber Seal	<b>62032RS-75</b>
40mm	17mm	12mm	Rubber Seal	<b>62032RS-17</b>
40mm	5/8" (15.875mm)	12mm	Rubber Seal	<b>62032RS-62</b>
42mm	20mm	12mm	Rubber Seal	<b>60042RS-20</b>
47mm	20mm	14mm	Rubber Seal	<b>62042RS-20</b>
47mm	3/4" (19.05mm)	14mm	Rubber Seal	<b>62042RS-75</b>
52mm	1" (25.4mm)	15mm	Rubber Seal	<b>62052RS-1</b>
52mm	25mm	15mm	Rubber Seal	<b>62052RS-25</b>

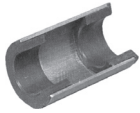

60042RS-20

## BEARING TYPES

	<p><b>PLAIN BORE WHEELS</b></p> <p>Are normally polypropylene, nylon or cast iron and are suitable for lighter loads where rolling resistance is not as important. They are used in very wet, corrosive or high heat conditions where better bearings would not survive.</p>
	<p><b>ROLLER BEARINGS</b></p> <p>Are suitable for medium duty applications. If kept well greased, they can cope with some dirt or water. Best service is given on hardened axles. These bearings do not require axial adjustment.</p>
	<p><b>PRECISION DEEP GROVE BALL BEARINGS</b></p> <p>Are fitted to most of our heavy duty wheels. Such wheels have very low rolling resistance and are normally provided with double seal bearings that are 'sealed for life.' If the application required regular greasing, grease nipples can be fitted.</p>
	<p><b>TAPER ROLLER BEARINGS</b></p> <p>Are the best choice for power towing applications and have the highest carrying capacity. All wheels with taper roller bearings are fitted with oil seal sleeves. The axle design must allow for fine adjustment of distance between bearing cones.</p>

**AGRICULTURE & MACHINERY BEARINGS - ROUND BORE**

(A)	(B)	(C)	(D)	Product Code
45.225mm	3/4"	15.49mm	-	<b>P204RR6</b>
40mm	16.256mm	18.29mm	12mm	<b>203KRR2</b>
100mm	55.575mm	33.34mm	-	<b>GW211PPB2</b>
125mm	70mm	39.69mm	-	<b>GW214PP2</b>
100mm	55.575mm	33.34mm	-	<b>W211PP2</b>
100mm	55.575mm	33.34mm	-	<b>W211PPB2</b>

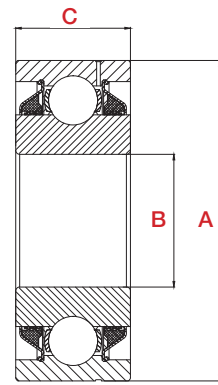

P204RR6

**AGRICULTURE & MACHINERY BEARINGS - SQUARE BORE**

(A)	(B)	(C)	(D)	Product Code
80mm	29.97mm	36.53mm	18mm	<b>W208PP5</b>
80mm	29.97mm	36.53mm	18mm	<b>W208PPB5</b>
85.74mm	29.97mm	36.53mm	30.18mm	<b>W208PPB12</b>
100mm	38.89mm	33.34mm	-	<b>GW211PPB3</b>
101.6mm	38.89mm	44.45mm	36.53mm	<b>GW211PP5</b>
100mm	38.89mm	50.8mm	33.34mm	<b>PDNF11008R3</b>
101.6mm	41mm	44.45mm	36.53mm	<b>W211PP34</b>
103.56mm	38.89mm	44.45mm	36.53mm	<b>W211PPB6</b>
100mm	41.20mm	33.34mm	-	<b>W211PP30</b>

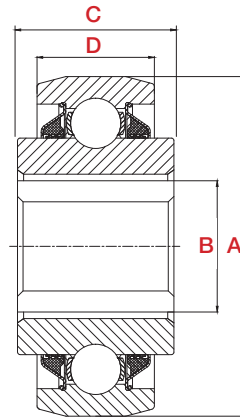

PDNF11008R3

**AGRICULTURE & MACHINERY BEARINGS - HEX BORE**

(A)	(B)	(C)	(D)	Product Code
52mm	7/8"	1"	15mm	<b>205KRRB2</b>
62mm	1"	24mm	16mm	<b>206KRRB6</b>

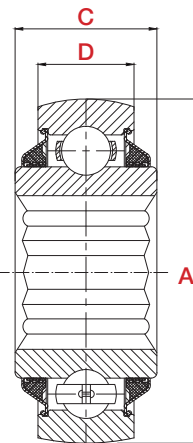
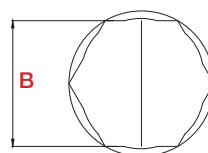

205KRRB2

**FLANGE-MOUNT SQUARE BALL BEARING UNIT: FOUR-BOLT FLANGE**

(A)	(B)	(C)	(D)	(E)	(F)	Product Code
139.7mm	41mm	139.7mm	50.95mm	<b>45.70MM</b>	13.5MM	<b>FD211RP</b>
127mm	29.85mm	127mm	44.45mm	<b>42MM</b>	13.5MM	<b>FD210R</b>

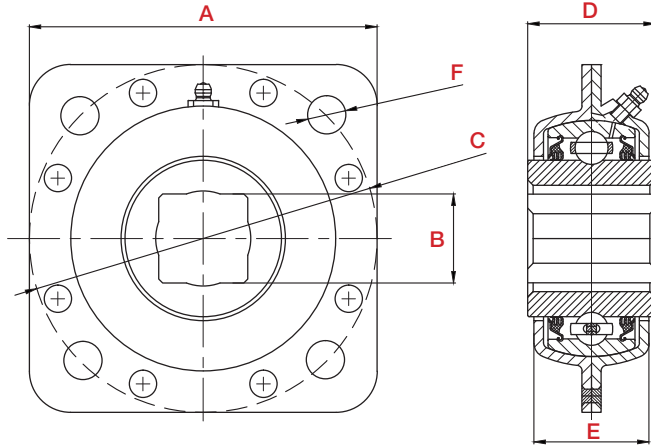

FD211RP

**FLANGE-MOUNT ROUND BALL BEARING UNIT: FOUR-BOLT FLANGE**

(A)	(B)	(C)	(D)	(E)	(F)	Product Code
139.7mm	55.563mm	139.7mm	13.5mm	<b>55.563MM</b>	46	<b>ST211-2</b>

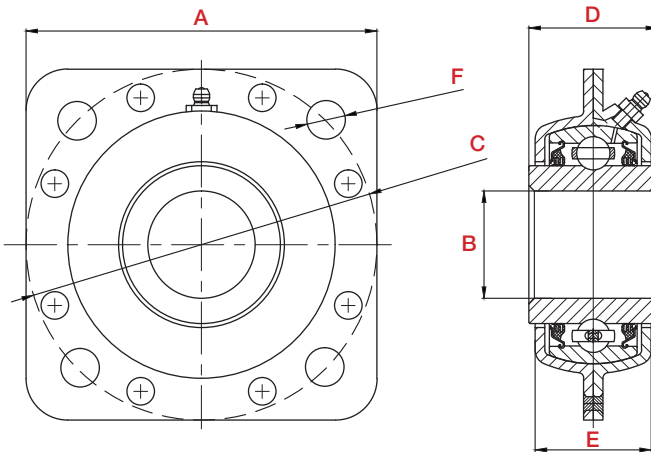

ST211-2

**BEARING KITS**

Description	Kit Code	<b>ALLOWS IMPERIAL SIZE BORES TO FIT METRIC AXLE SIZES</b>
To suit 20mm axle, fits any wheel with a 40mm I.D. bearing pocket	BUSH20MMBRG	
To suit 25mm axle, fits any wheel with a 2" I.D. bearing pocket	BUSH25MMBRG	

# AXLES

Richmond can supply a full range of bearings, axles and fasteners including bolts, nuts and washers to suit all of our castors and wheels.

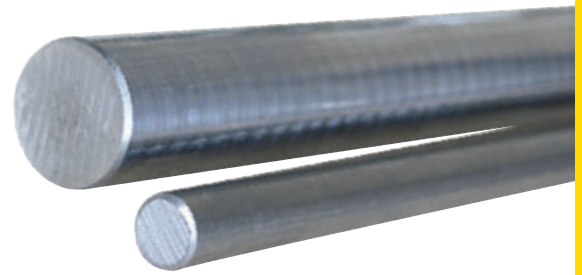

## AXLES

Diameter	Length (mm)	Product Code
1/2"	900	AXLE-50X900
5/8"	900	AXLE-62X900
3/4"	900	AXLE-75X900
1"	900	AXLE-1X900

## AXLE CAPS

Metal axle caps available to suit a range of axle sizes. Easy knock on installation.

Suits Axle Size	Pack Qty	Product Code
1/2"	4	AXLECAP50
5/8"	4	AXLECAP625
3/8"	4	AXLECAP350
3/4"	4	AXLECAP750



AXLECAP750

## BEACH WHEEL AXLES & AXLE KITS

Aluminium axles to suit Richmond's range of beach wheels. Axle mounting kits available to suit both 20mm and 1" axle sizes.

Diameter	Length (mm)	Product Code
20mm	1200	AXLE20X1200
1" (25.4mm)	1200	AXLE1X1200

Axle Mounting Kit to suit 20mm Aluminium Axle	AXLEKIT20-AL
Axle Mounting Kit to suit 1" Aluminium Axle	AXLEKIT-1AL



AXLE20X1200



AXLEKIT-20AL

**Axle kit includes:** 2x U-Bolts, 2x Aluminium U-Brackets, 4x Aluminum Tubes, 4x Lynch Pins, 4x Nylon Lock Nuts, and 4x Flat Washers

# BUFFERS

These non-marking round corner and D section buffers are a great way to protect doors and corridor walls. Round buffers are fitted onto a round/square RHS tube and Corner and D section buffers are fitted using self tapering screws.

Ideal for use on flat bed trolleys, mobile tables, as well as hospital beds and equipment. We can also manufacture different shapes and sizes in polyurethane to suit your requirements.



## PVC ROUND BUFFERS - ROUND & SQUARE TUBE FITTING

Buffer Description	Measurement	Product Code
Round Buffer	Suit 25mm SQUARE x 125 DIA	<b>BUFFER12</b>
Round Buffer	Suit 25mm ROUND x 125 DIA	<b>BUFFER13</b>
Round Buffer	Suit 32mm ROUND x 125 DIA	<b>BUFFER14</b>
Round Buffer	Suit 38mm x 2mm RHS x 125mm DIA	<b>BUFFER15</b>

Fitted to square or round tubular trolley legs before castors, the buffer sits loosely on top of the castor, absorbing and reducing damage.

## PVC ROUND BUFFERS - ROUND & SQUARE TUBE FITTING

Buffer Description	Measurement	Product Code
Round Buffer	Suit 25mm SQUARE x 125 DIA	<b>BUFFER02</b>
Round Buffer	Suit 25mm ROUND x 125 DIA	<b>BUFFER06</b>

Fitted to square or round tubular trolley legs before castors, the buffer sits loosely on top of the castor, absorbing and reducing damage.

## CORNER BUFFERS

Buffer Description	Measurement	Product Code
Corner Buffer	50mm x 19mm	<b>BUFFER04</b>
Corner Buffer	65mm x 25mm	<b>BUFFER05</b>
Corner Buffer	75mm x 25mm	<b>BUFFER01</b>
Corner Buffer	110mm x 25mm	<b>BUFFER16</b>
Corner Buffer	103mm x 35mm	<b>BUFFER17</b>

Corner buffers are fitted to the square edges of new or existing trolleys to cushion impact against walls or doors.

## D SECTION BUFFER

Buffer Description	Measurement	Product Code
D Section Buffer	20mm x 30mm W x 7 MTR	<b>BUFFER07</b>

D Section buffers are used to run along trolley edges between corner buffers.

# TRICASTOR STAGE DOLLIES

Custom designed and manufactured by our in-house engineering team, these dollies feature a heavy duty, robust top plate and a high load capacity. These dollies can manoeuvre heavy loads with ease, even in tight spaces making them ideal for theatrical sets and stage equipment.

These dollies provide easy mobility to your sets and equipment and keep your production running by reducing strain and overexertion to the crew as they move sets and equipment around the stage.

The design of these triple wheel dollies is customisable to accommodate a range of different wheel types and capacities. Richmond can custom design and manufacture heavy duty dollies up to 20 tonne to suit to customers requirements.

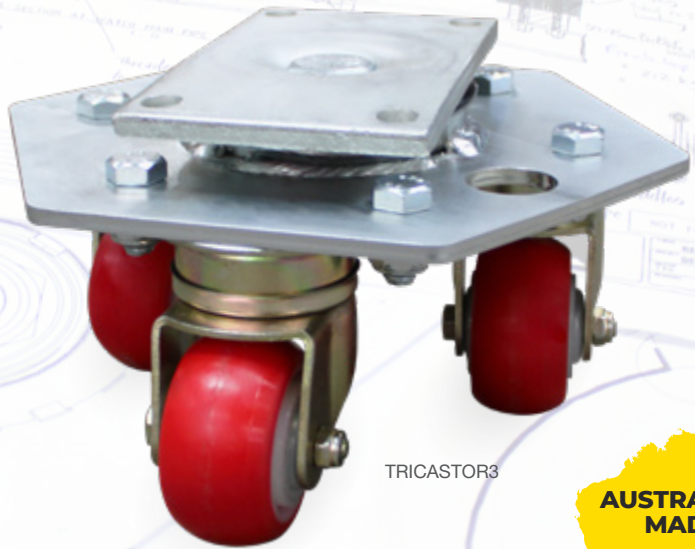

TRICASTOR3



TRICASTOR9

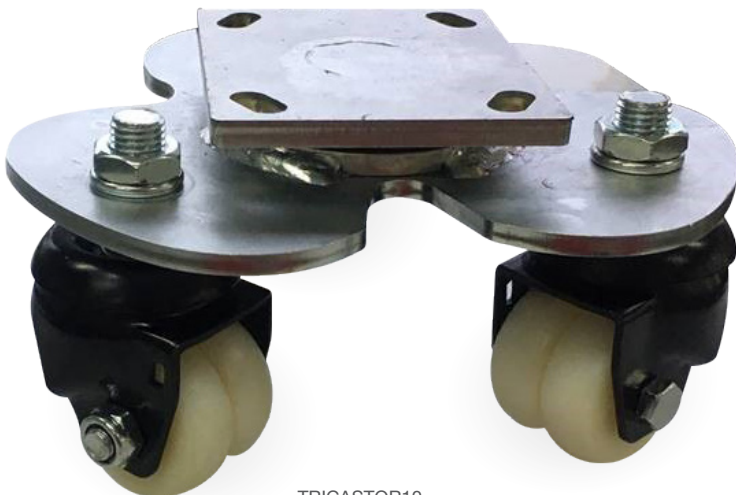

TRICASTOR10

**Contact  
our expert  
team to  
design your  
custom  
solution**

## CUSTOM DESIGNED AND MANUFACTURED

Manufactured by our expert team with decades of experience.

## A HUGE RANGE OF WHEEL OPTIONS AVAILABLE

Choose from our extensive range of wheel types and materials to customise the perfect dolly to suit your application.

# TAILORED ENGINEERING SERVICES

Specialising in the design and manufacturing of practical turnkey solutions. Need to move something big and heavy? We have what you need.

## HOW DO WE DEVELOP THE BEST SOLUTION FOR YOU?

**At Richmond Wheel and Castor Co. we understand that when it comes to developing tailored solutions it is critical that we:**

- Closely consult with our customers from the beginning and validate throughout the design process. The earlier we are involved at the design stage, the easier it is to develop the optimum solution.
- Follow an ISO9001 structured process to ensure all details are managed.

This methodology has ensured our customers are always delivered a cost effective and practical solution and continue to return to Richmond Wheel & Castor Co. for their tailored materials handling requirements.

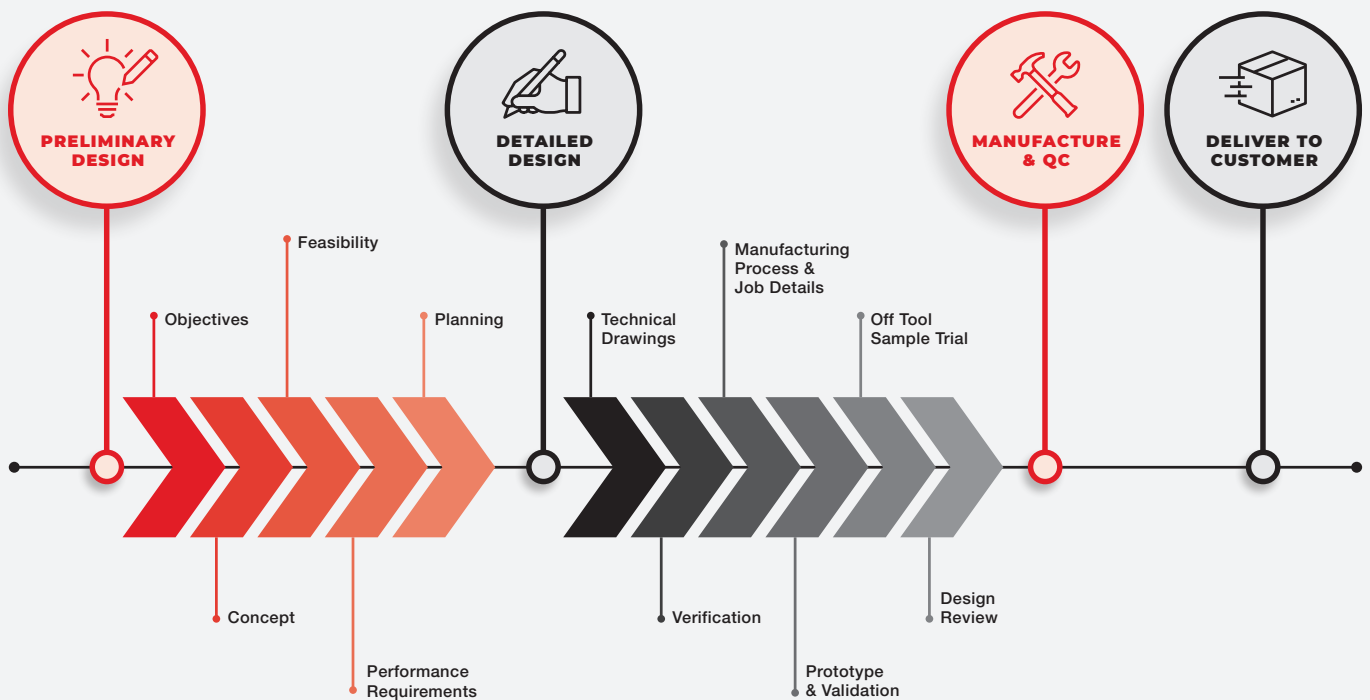

Our engineering department can custom design a solution to meet your requirements.

**Contact us to find out how we can help with your project.**

# CASE STUDIES



## **JOBO MASCINEN GMBH**

### **PIPE ROLLER DESIGN AND MANUFACTURE**

**Brief:** Design and manufacture 150 large scale pipe rollers to launch pipe from on-shore to an off-shore docking platform as a part of a major infrastructure upgrade for oil and gas pipelines in Nigeria. These stackable, twin roller assemblies easily nest inside of a shipping container for transport or storage.

**Image:** One of our largest engineering projects to date. The success of the rollers demonstrates our ability to provide a complete turnkey solution from start to finish, including all design, material selection, verification, testing and construction.



## **JOHN ROBBINS (USA)**

### **TUNNEL BORING BOGIES AND COMPONENTS**

**Brief:** Supply of 80 x 40-ton capacity tunnel boring bogies, 2 x 80-ton tunnel boring super bogies, and a wide variety of tunnel boring plastic wear plate components, heavy duty weldments, heavy duty guide rollers and FRAS (fire retardant anti-static polymer components).

**Image:** Bogies and components in action on tunnel boring machinery.

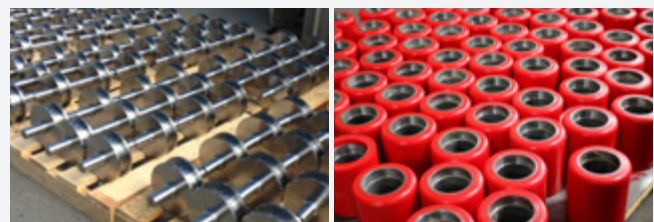

## **CUSTOM WHEELS & ROLLERS**

**CUSTOM WHEELS AND ROLLERS CAN BE DESIGNED, MANUFACTURED, AND ASSEMBLED TO SUIT YOUR PROJECT REQUIREMENTS**



**HEDWELD ENGINEERING**

**HIGH CAPACITY SKID STEER WHEELS FOR TYRE STAND**

**Brief:** Supply of 40-Ton capacity skid steer wheels for mining machinery maintenance.

**Image:** Castors in action on tyre stand.



**JOHN HOLLAND**

**TRENCHLESS PIPELINE ROLLERS**

**Brief:** Design and manufacture a 10-ton load capacity pipe roller solution for the transport of water mains pipe through tunnels.

**Image:** This simple and efficient design allows for large carrying capacity and safety at the lowest possible cost.



**DOWNER EDI**

**HIGH CAPACITY CASTORS**

**Brief:** Design and manufacture 16 x 10-ton capacity castors.

**Image:** 16 x 10-ton capacity castors packed and ready for delivery.



**CONFIDENTIAL**

**WHEELS FOR WAVE MAKING MACHINE**

**Brief:** Design and manufacture heavy duty linear support wheels for wave making machinery.

**Image left:** Machinery produces perfect surfing waves in a man-made lake.

**Image right:** Linear support wheels straight off the production line.

**“ WHAT DOES THE INDUSTRY HAVE TO SAY ABOUT US? ”**

“Richmond Wheel and Castor Co. is a genuine Australian success story. Since its humble beginnings as a one-man steel trading operation in the 1950s, three generations of the Winslow family have steered the business through recessions, downturns and the global financial crisis to its commanding current day position as one of the longest standing – and most successful – materials manufacturers in Australia.”

*CSS, FAT Mag, October 2015*

“Richmond met and exceeded the stringent timeline requirements and, utilised manufacturing and assembly in both Melbourne and Perth to ensure satisfactory completion in a compressed timeline.”

*Regarding Perth slipway project. Manufacturers' Monthly, May 2018*

“Richmond is at the forefront of engineered materials handling solutions, including heavy duty castors, machined componentry, wheels, general engineering works and direct access to onsite engineers.”

*The Australian Pipeliner, official magazine of the Australian Pipelines and Gas Association. March 2016*

“Having supplied key infrastructure for Christies Beach Wastewater Treatment Plant and various other major Australian projects, Richmond Wheel and Castors get products and projects moving on custom-built wheels.”

*The Australian Pipeliner, March 2016*



# CUSTOM PIPE ROLLER SOLUTIONS

Here at Richmond, rolling solutions are what we do best. We've been working with the pipeline industry for decades, and our experience is unmatched in the industry. Richmond can design and supply a large range of equipment to the pipeline industry such as:

- Lightweight horizontal rollers
- Bogey transition system rollers
- Stackable pipeline rollers
- Pipe band support rollers
- Precision adjustable pipe rollers
- Pipe roller support slings

Our in-house engineering team can design and manufacture pipe roller equipment to any specification. Big or small, we do it all.

